

# DETALLES DE INSTALACIÓN DE BANDEJAS PORTA CABLES DEL TIPO MALLA

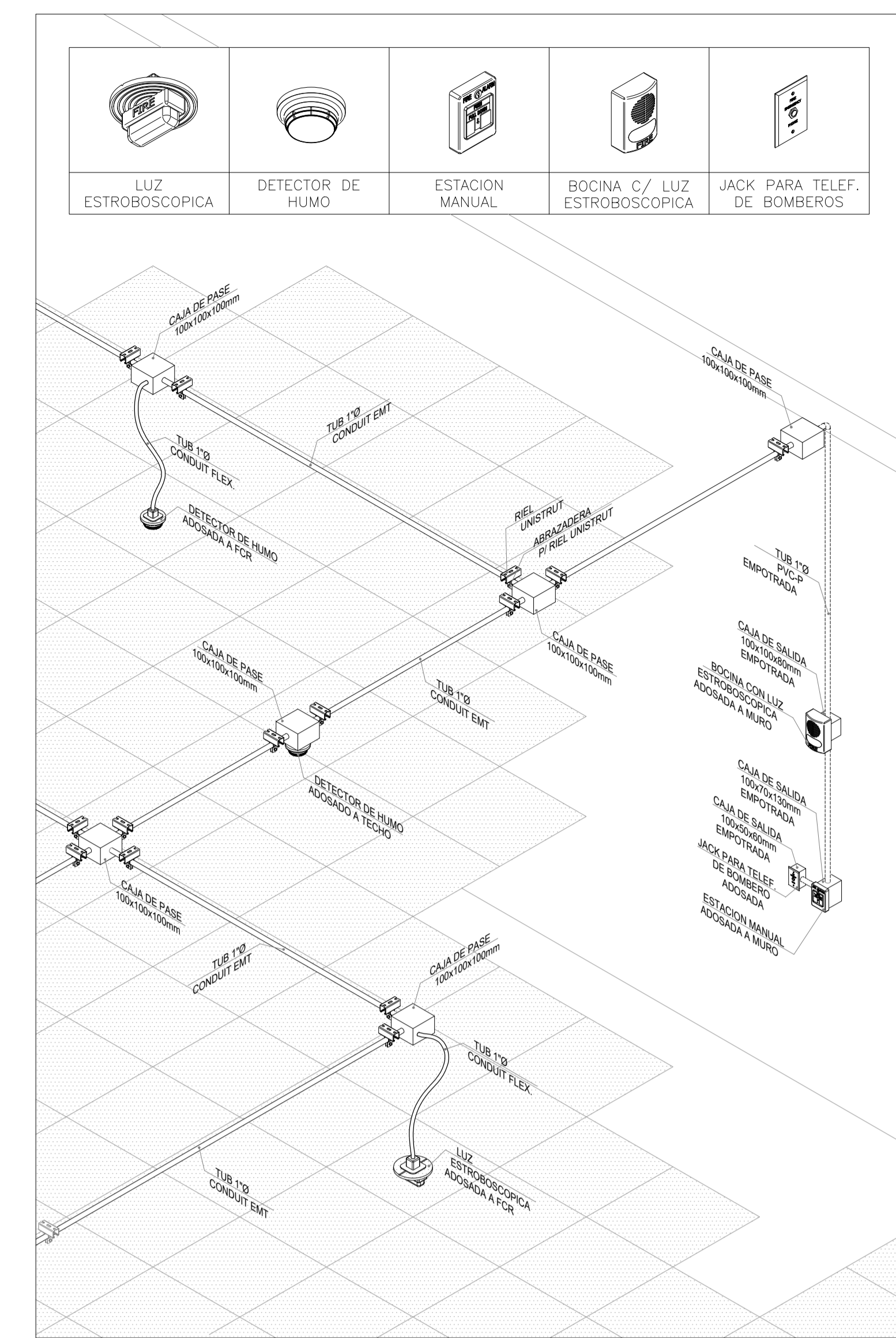
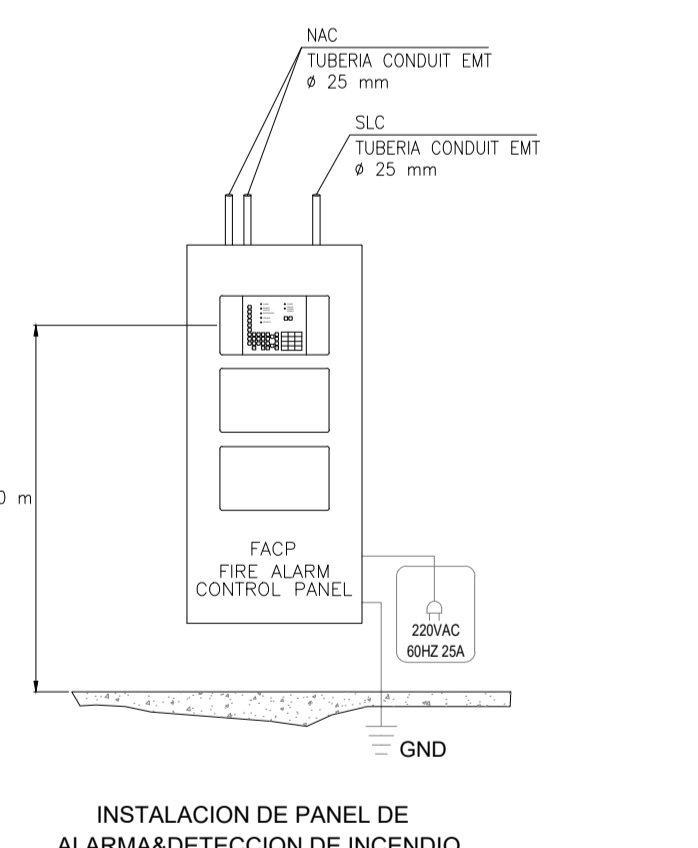
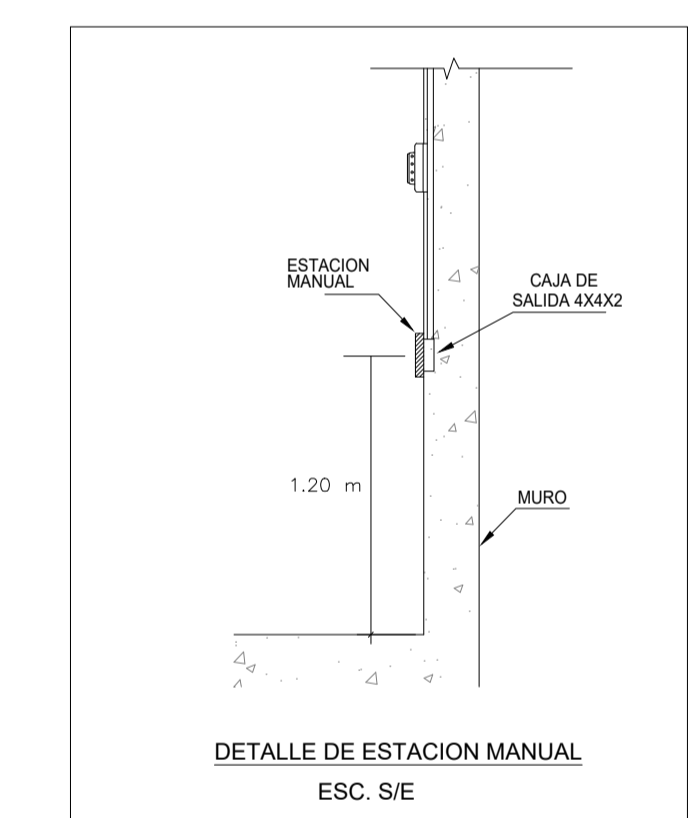
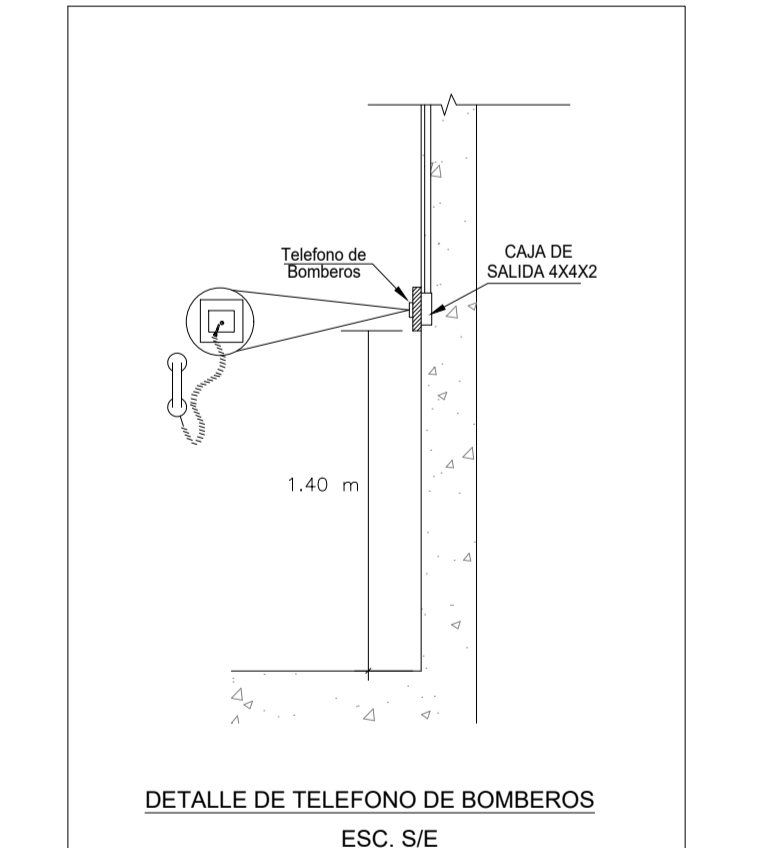
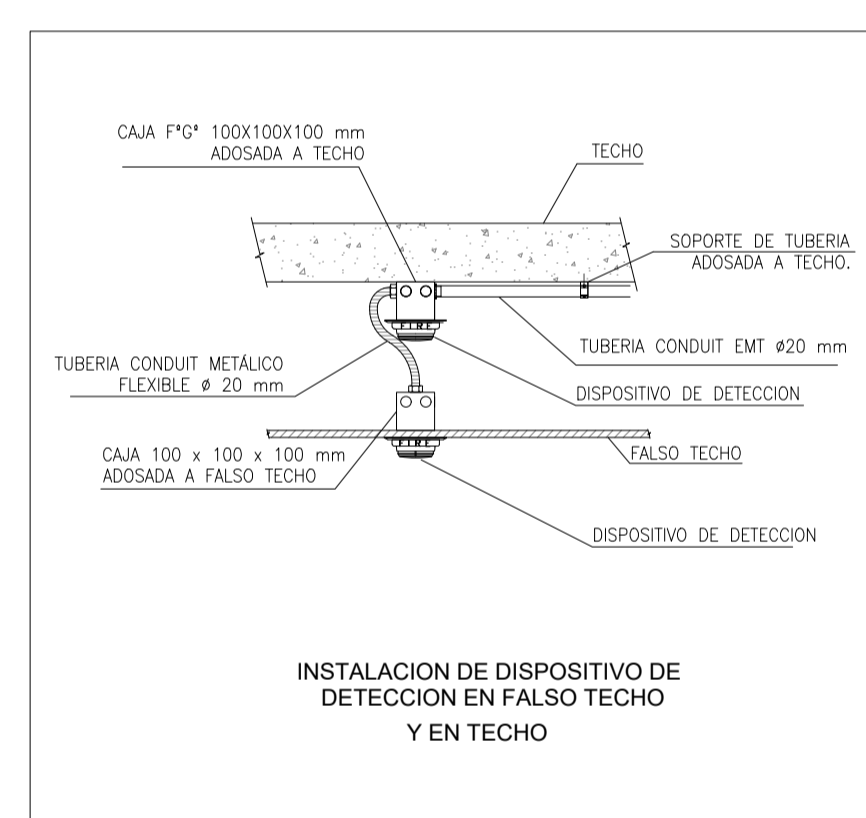
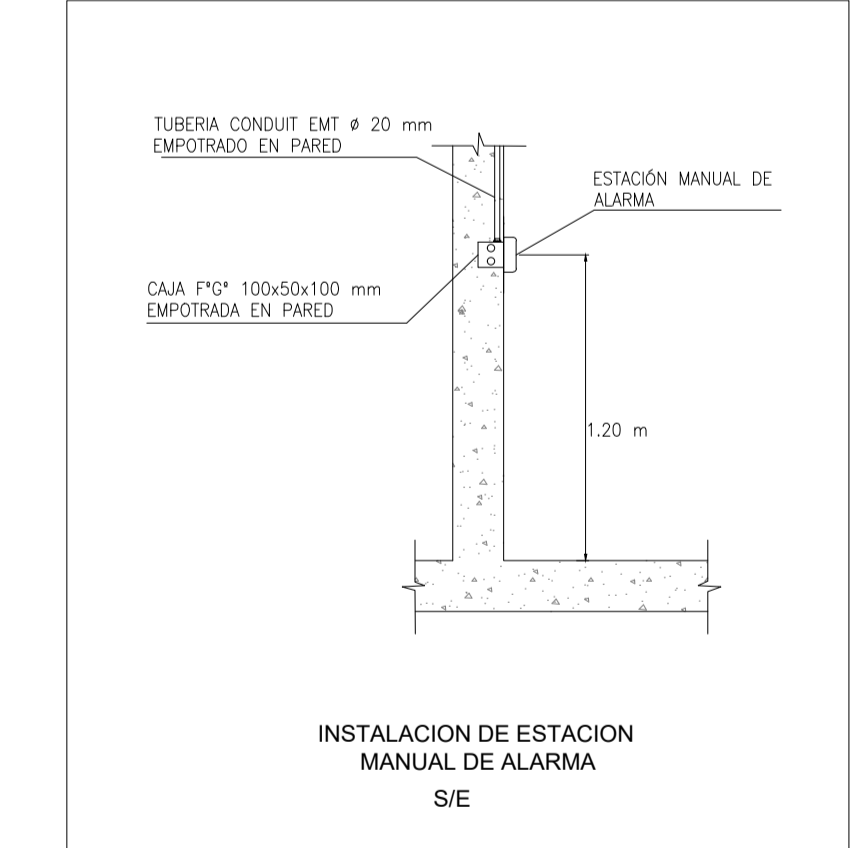
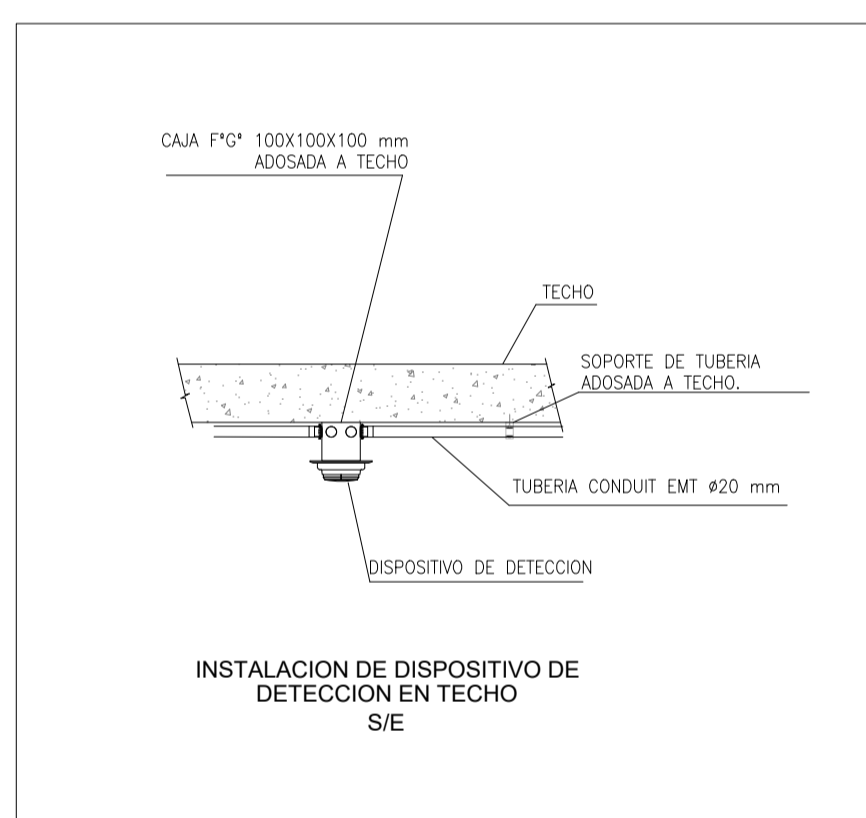
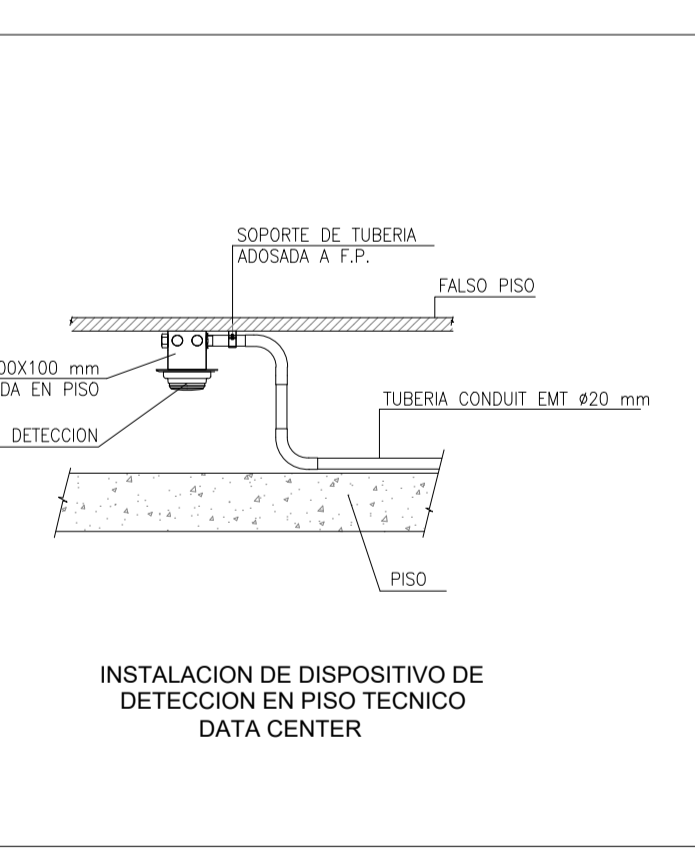
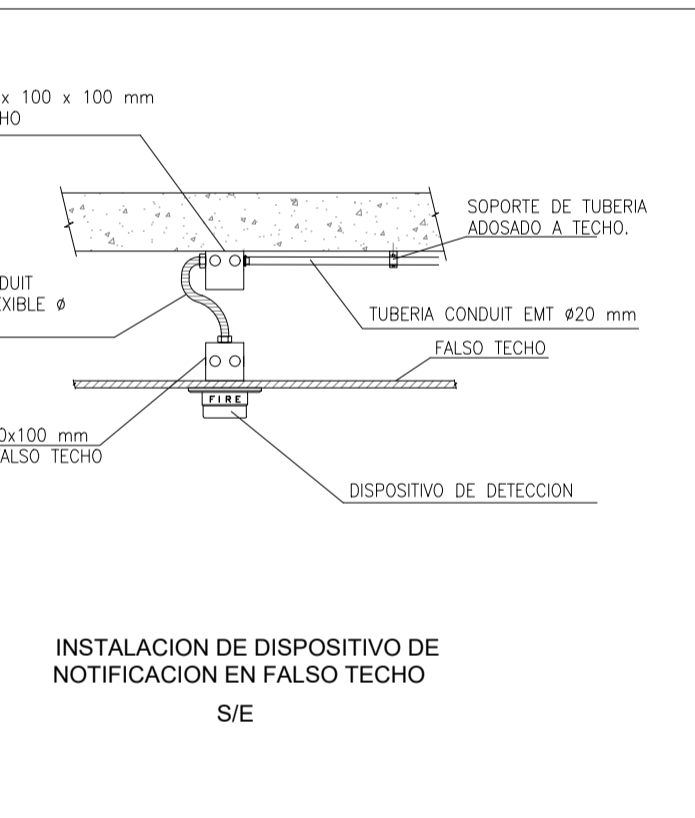
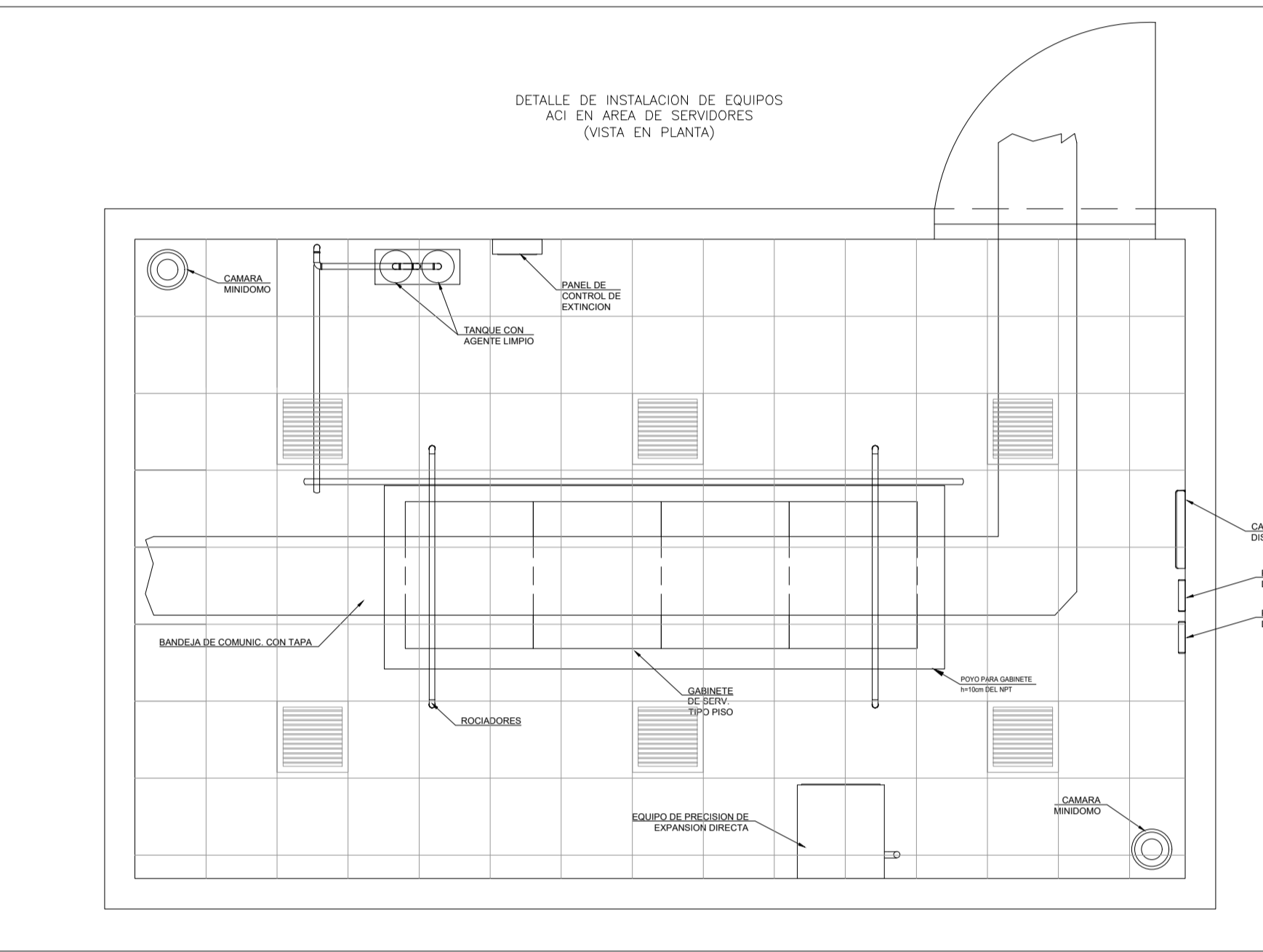
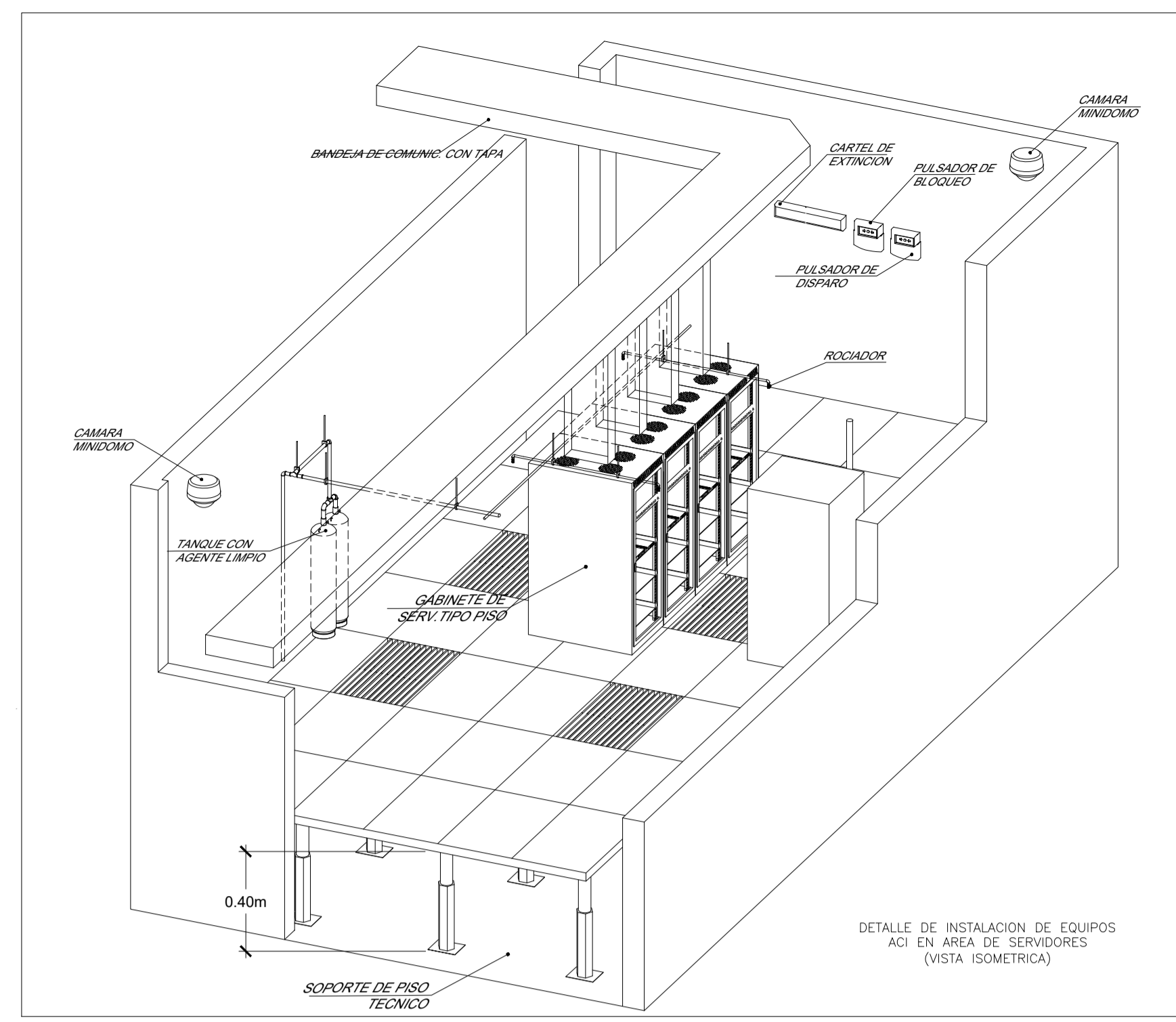
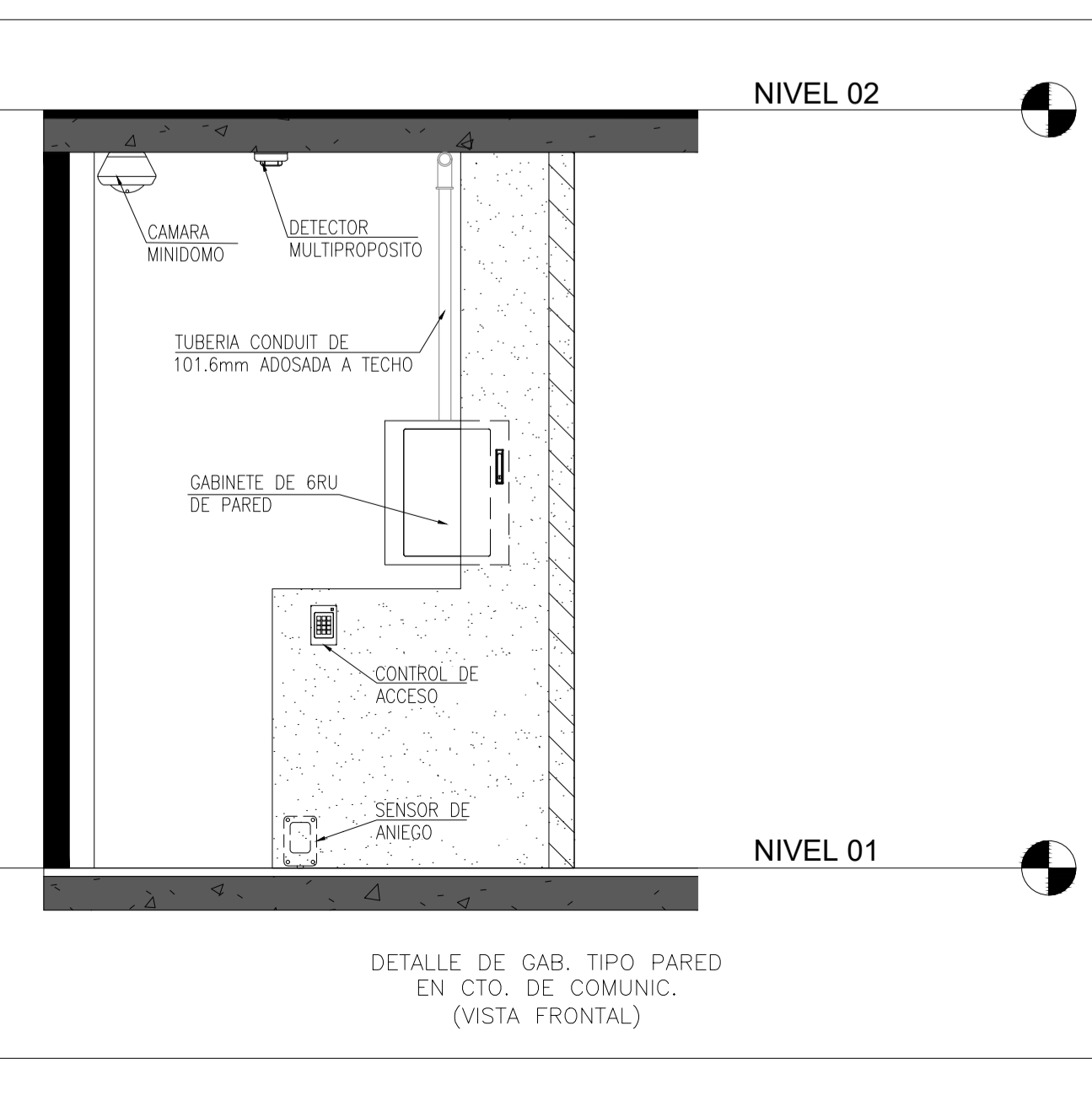
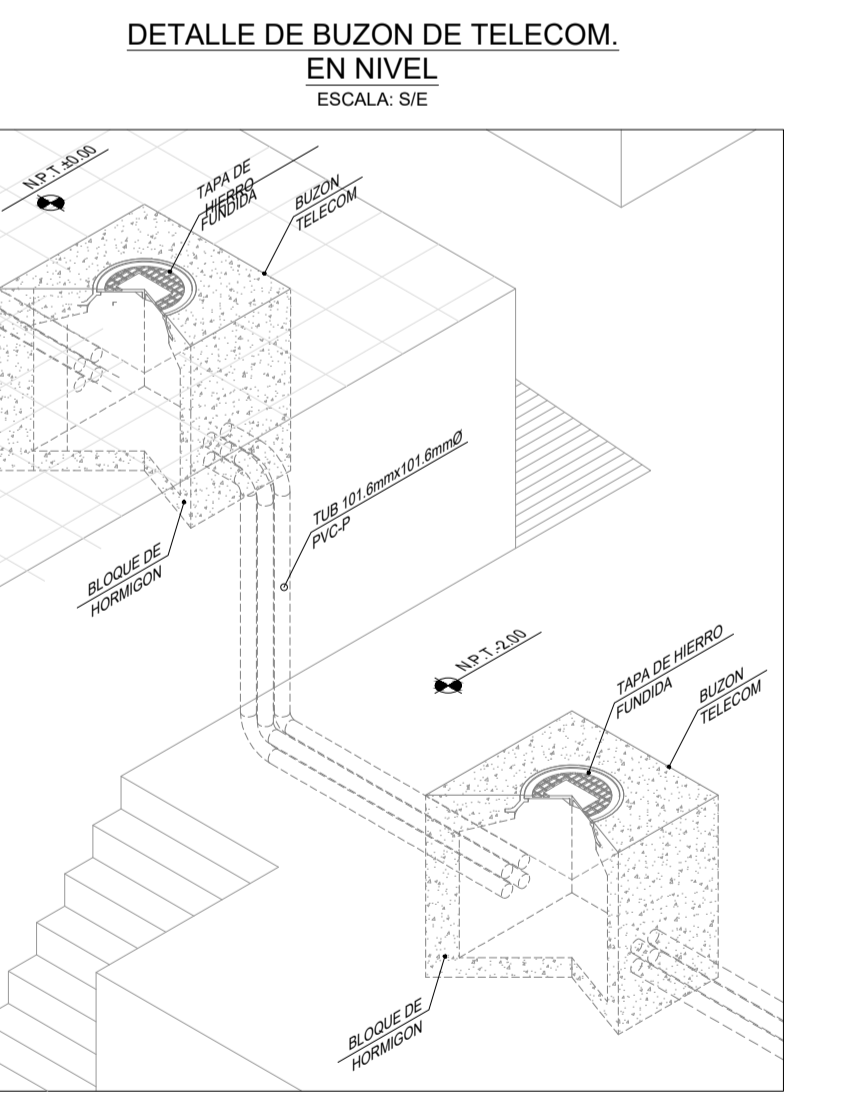
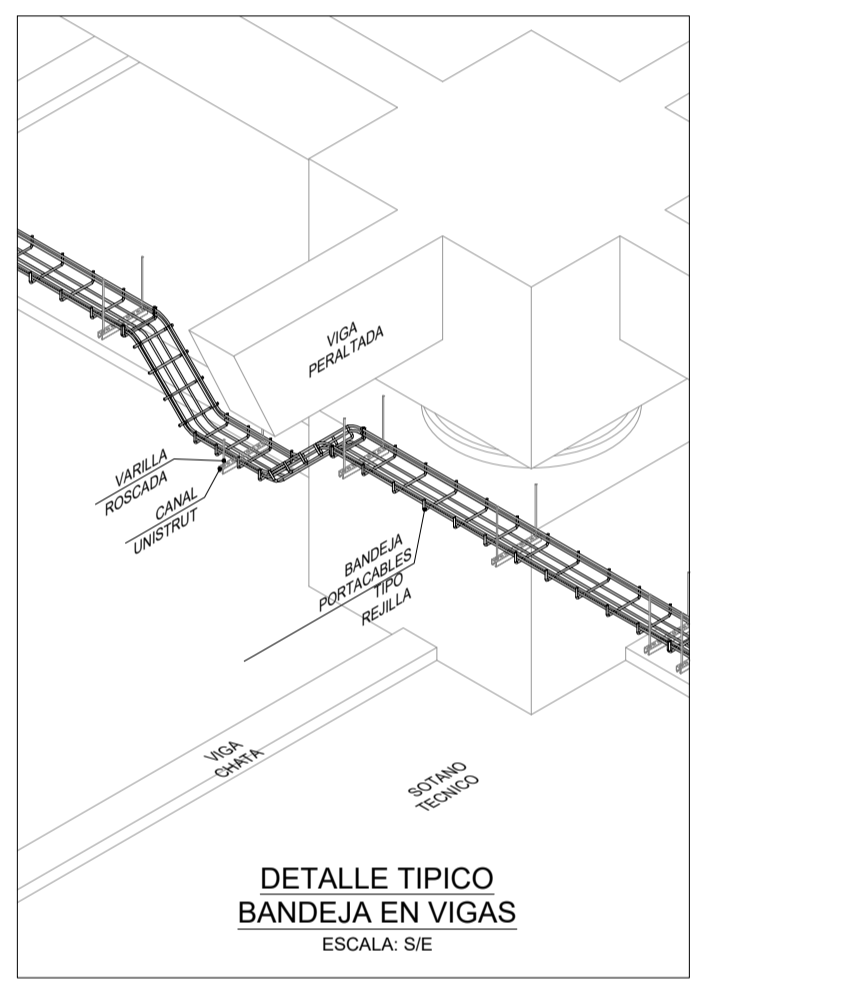
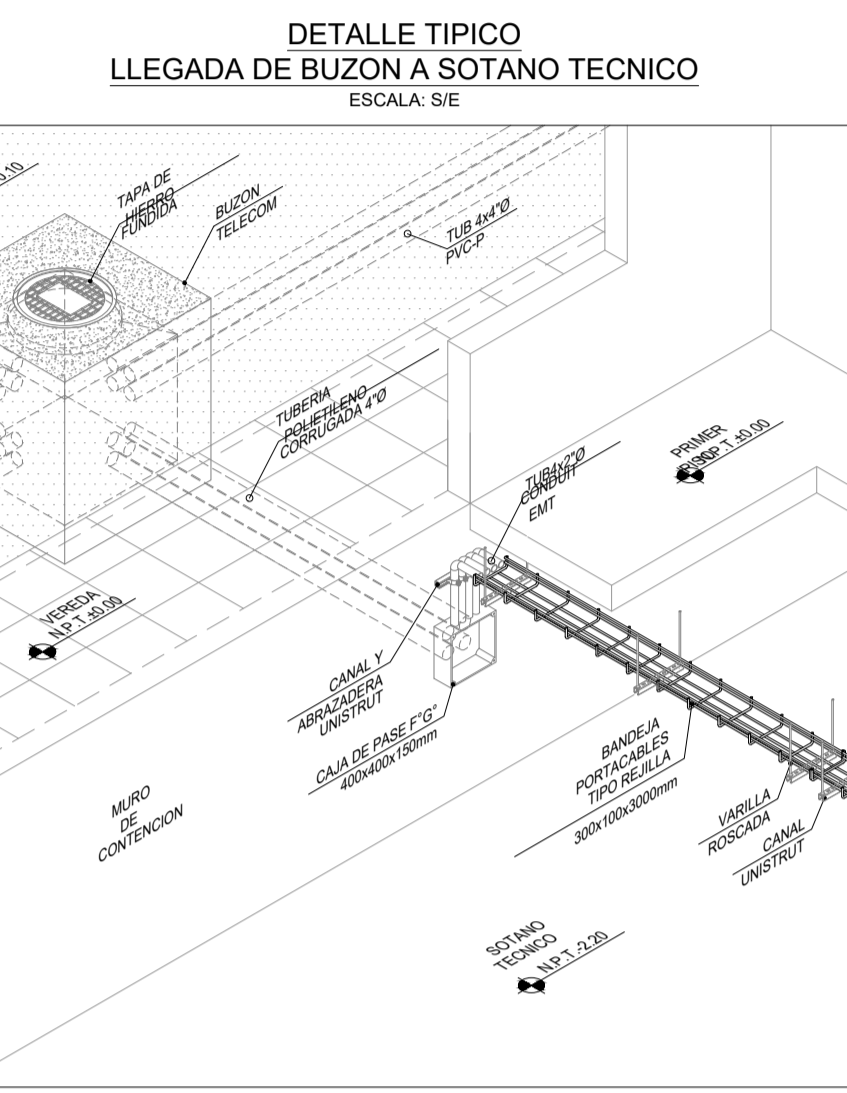
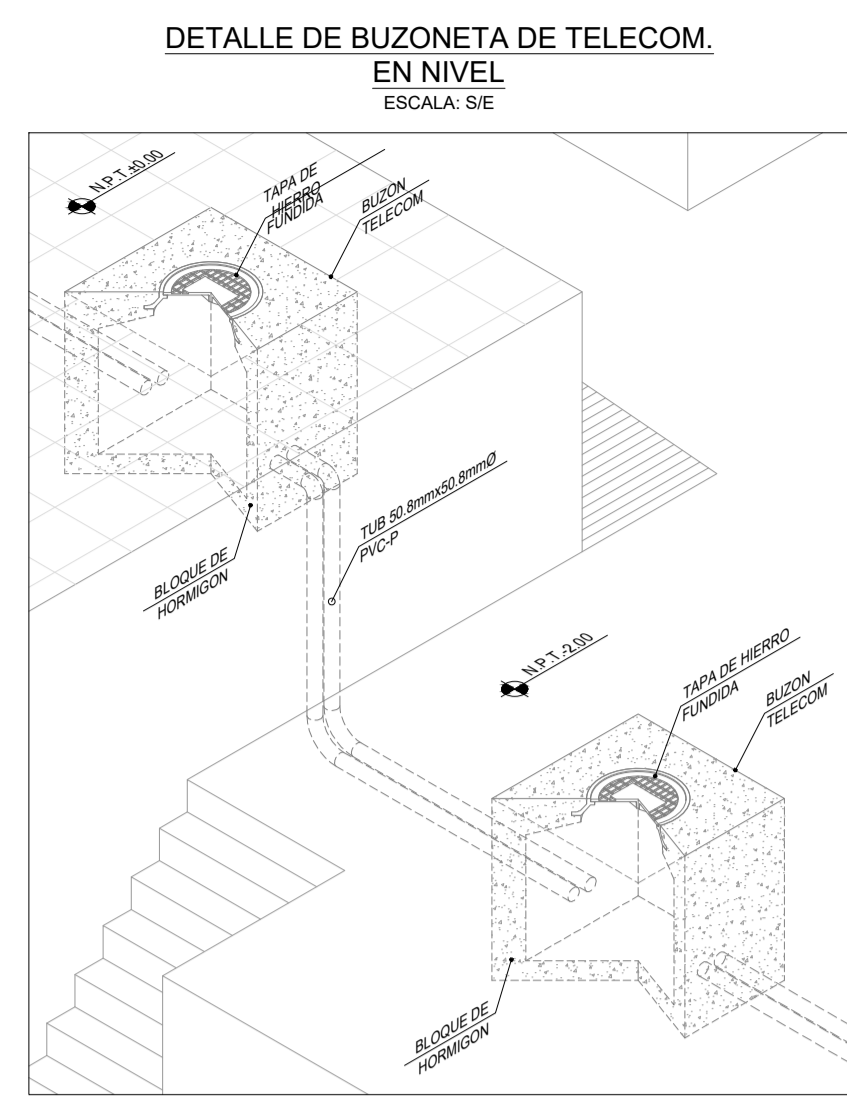
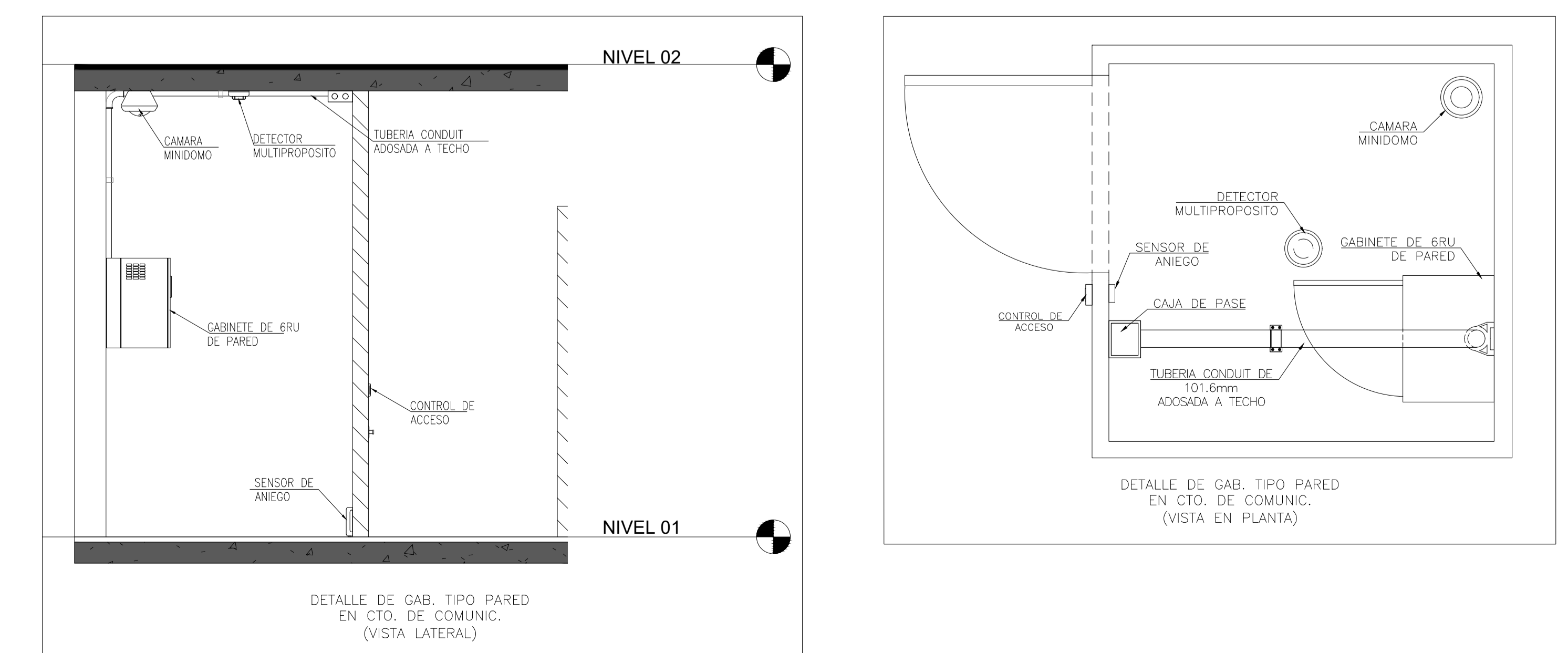
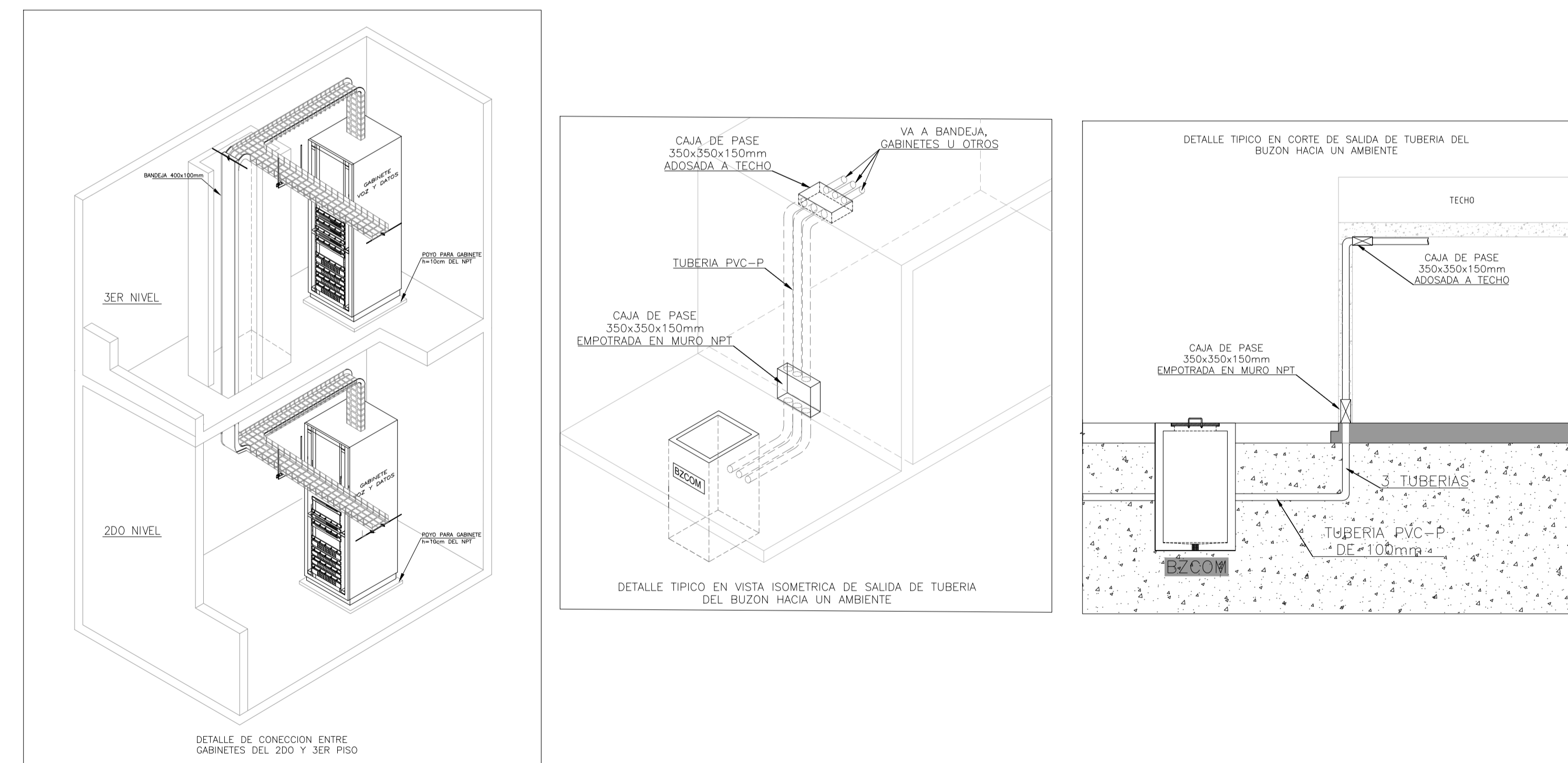
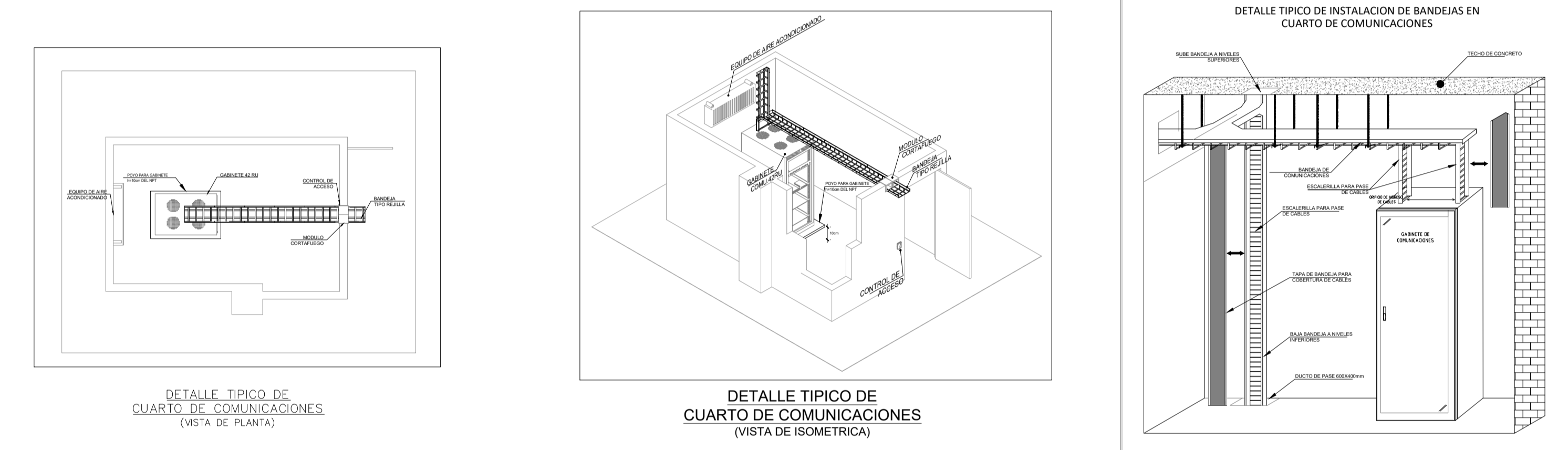
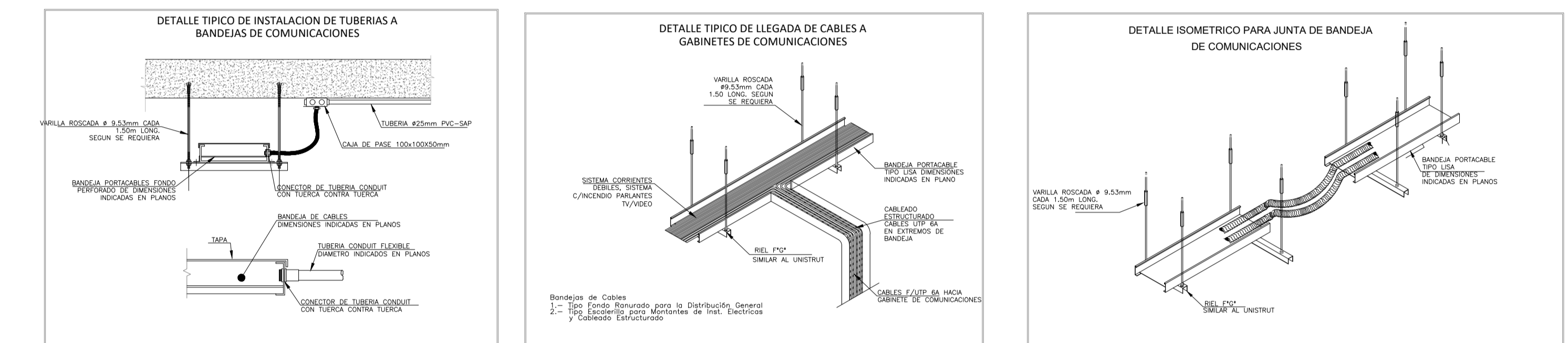
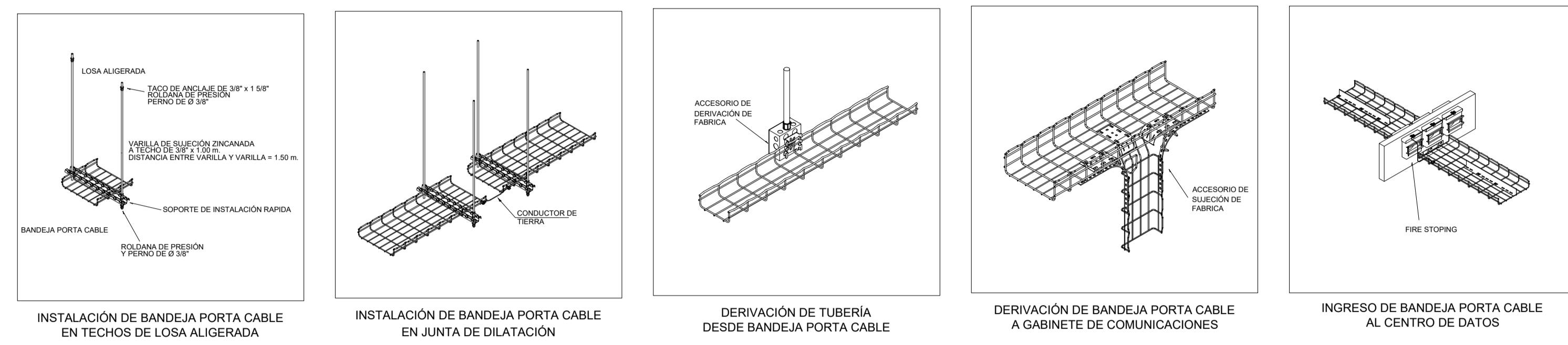
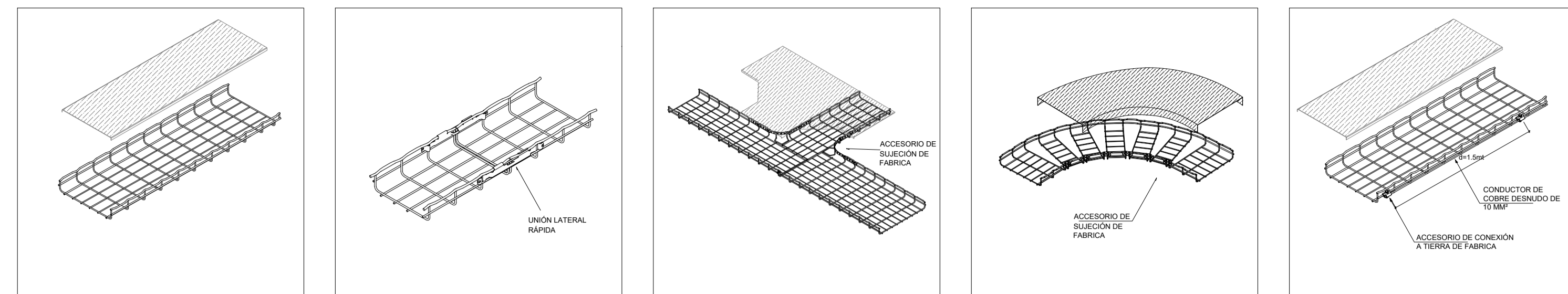

OBSERVACIONES

FIRMA: JEFE DE PROYECTO

FIRMA DE PROYECTISTA

FIRMA DE SUPERVISOR

PLANO CLAVE

BUSÓN / PISO	ESPESOR / CANTIDAD	TIPO DE CABLE
BUSÓN # 1er PISO	250x200x150mm	CONDUCTOR DE CABLE ESTERILIZADO 10/10
BUSÓN # 2do PISO	250x200x150mm	CONDUCTOR DE CABLE ESTERILIZADO 10/10
BUSÓN # 3er PISO	250x200x150mm	CONDUCTOR DE CABLE ESTERILIZADO 10/10
BUSÓN # 4to PISO	250x200x150mm	CONDUCTOR DE CABLE ESTERILIZADO 10/10
BUSÓN # 5to PISO	250x200x150mm	CONDUCTOR DE CABLE ESTERILIZADO 10/10
BUSÓN # 6to PISO	250x200x150mm	CONDUCTOR DE CABLE ESTERILIZADO 10/10
BUSÓN # 7to PISO	250x200x150mm	CONDUCTOR DE CABLE ESTERILIZADO 10/10
BUSÓN # 8to PISO	250x200x150mm	CONDUCTOR DE CABLE ESTERILIZADO 10/10
BUSÓN # 9to PISO	250x200x150mm	CONDUCTOR DE CABLE ESTERILIZADO 10/10
BUSÓN # 10to PISO	250x200x150mm	CONDUCTOR DE CABLE ESTERILIZADO 10/10

PROYECTO: ELABORACION DEL EXPEDIENTE TECNICO, EQUIPAMIENTO Y CONTINGENCIA DEL PROYECTO "RECONSTRUCCION DEL HOSPITAL SAUL GARRIDO ROSILLO IN-1, DISTRITO DE TUMBES, PROVINCIA DE TUMBES, DEPARTAMENTO DE TUMBES"

UBICACION: TUMBES, TUMBES, TUMBES

ESPECIALIDAD: COMUNICACIONES

PLANO: DETALLES DE BANDEJAS-BUZONES Y ACI

ELABORADO POR: CONSORCIO CONSULTOR SAUL GARRIDO RUC: 2060779638

PROFESIONAL RESPONSABLE: ING. CARLOS D. GUZMAN UBILLIUS CIP: 046597

CAD: ARCHIVO

FECHA: ABRIL 2022 ESCALA: SE

LÁMINA: DE-02