

03. DETALLES DE CANALIZACIONES HORIZONTALES

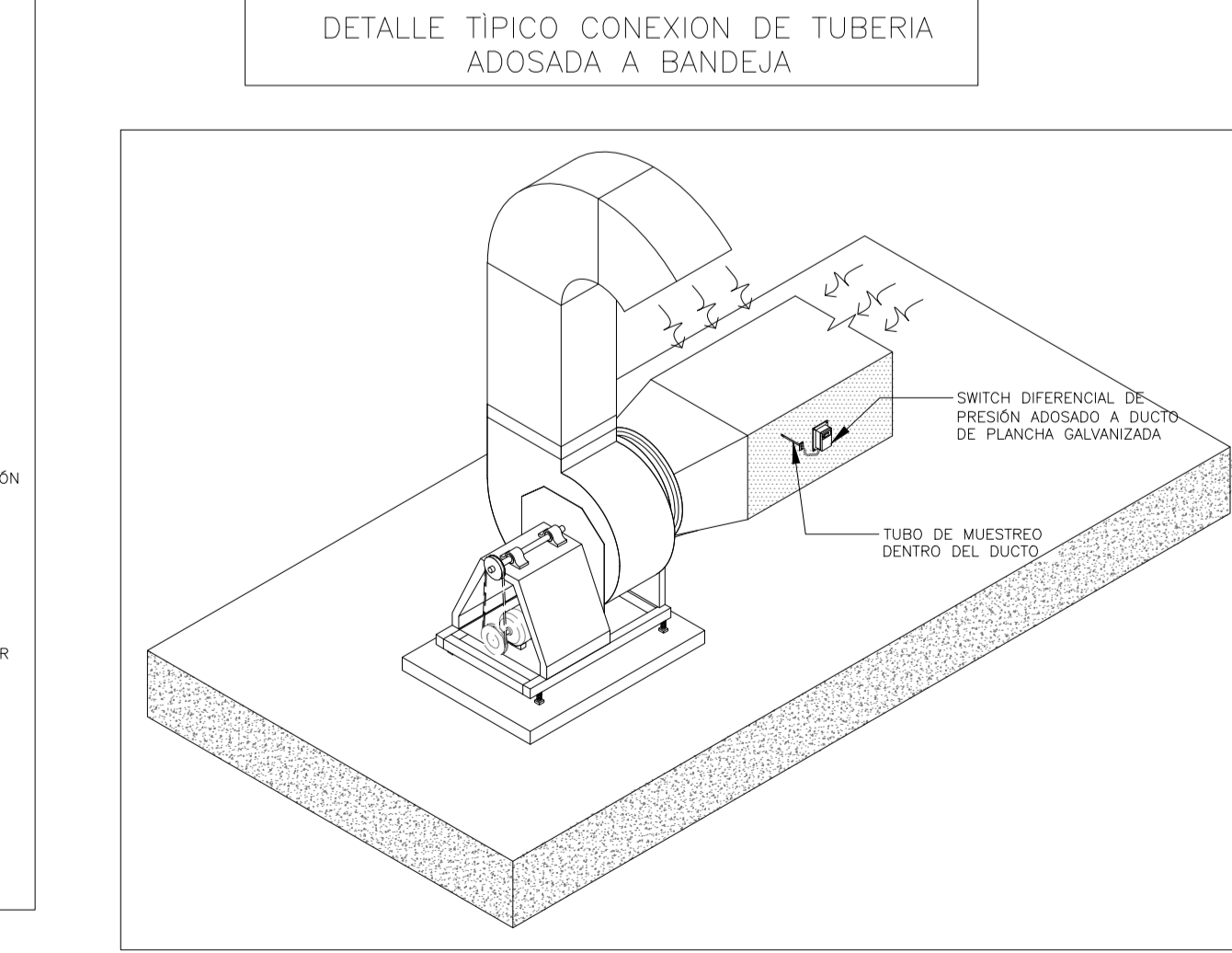
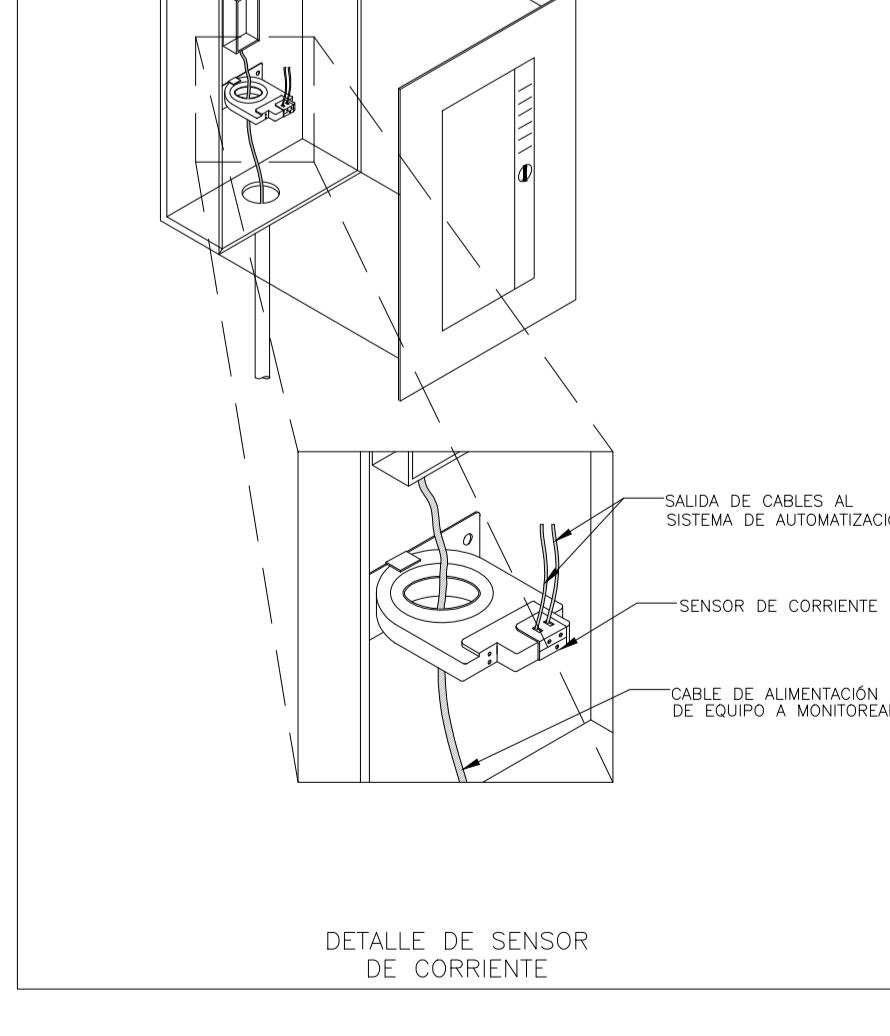
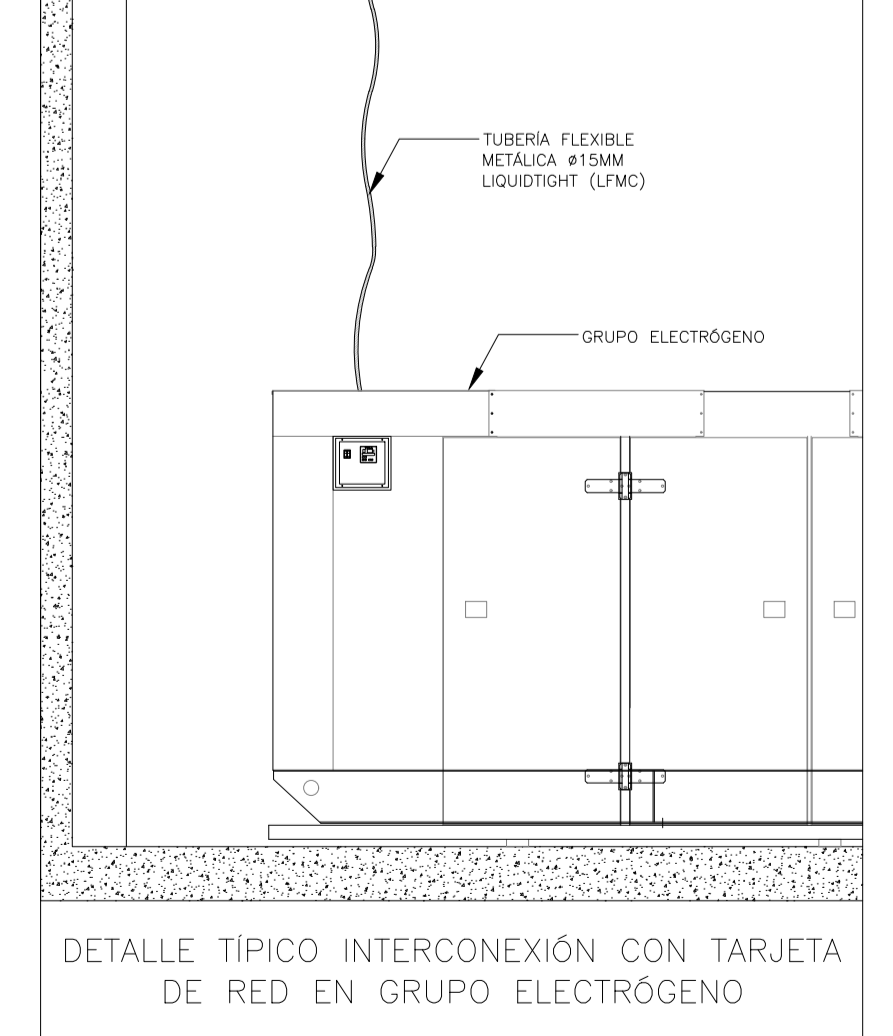
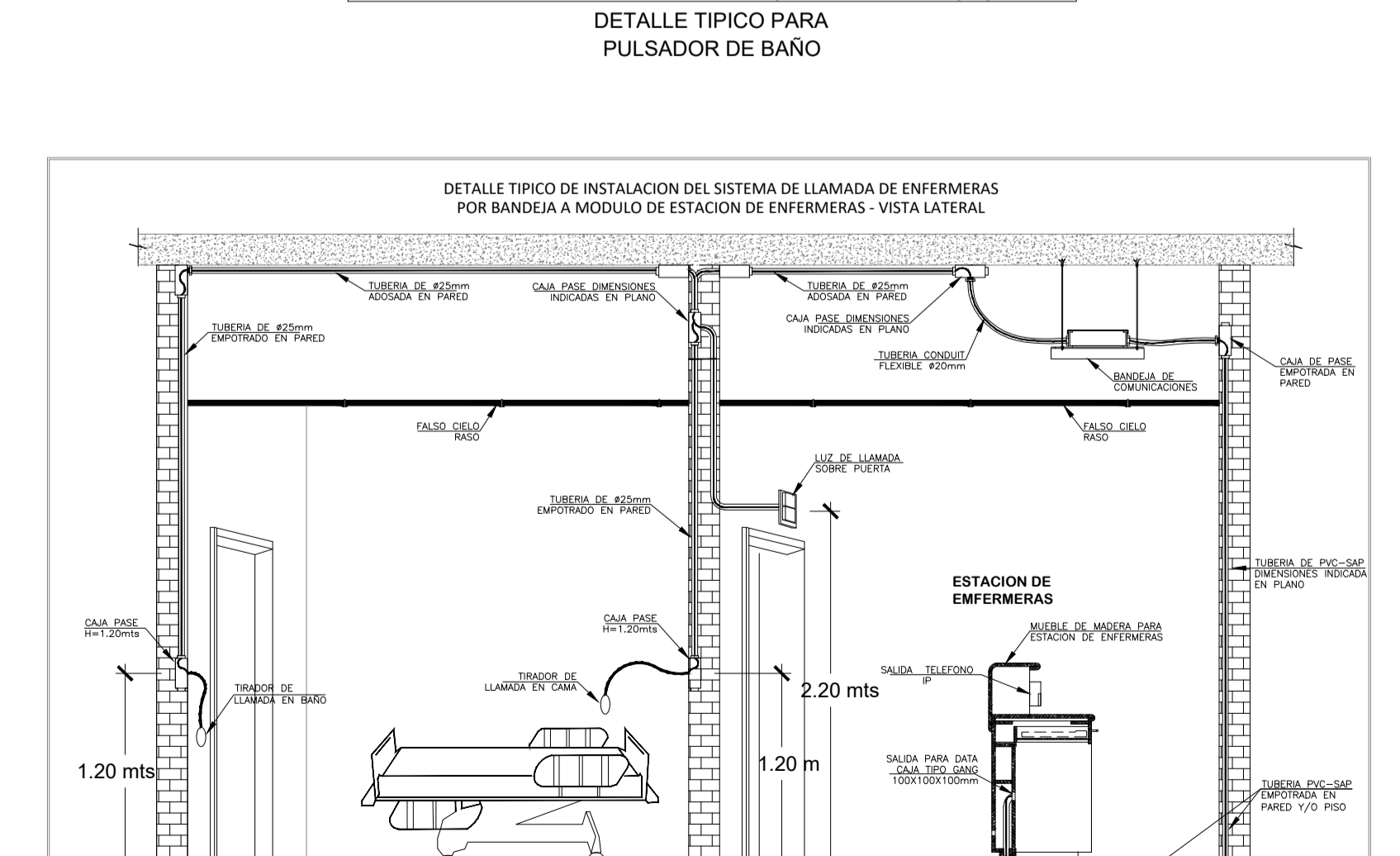
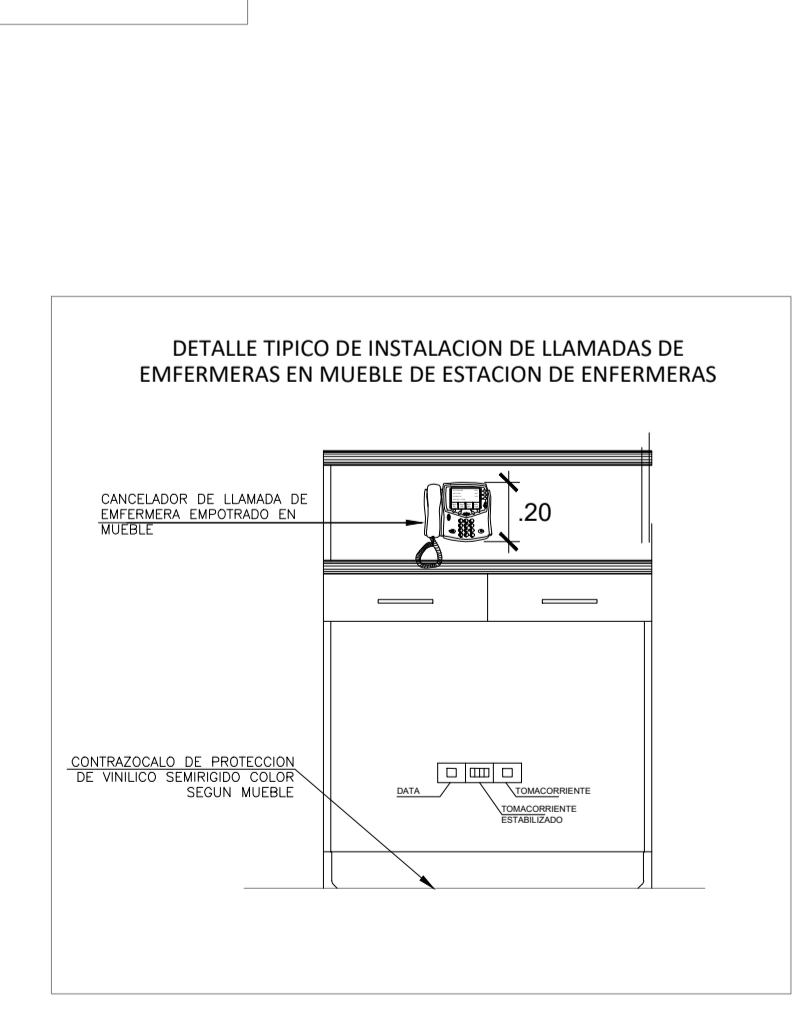
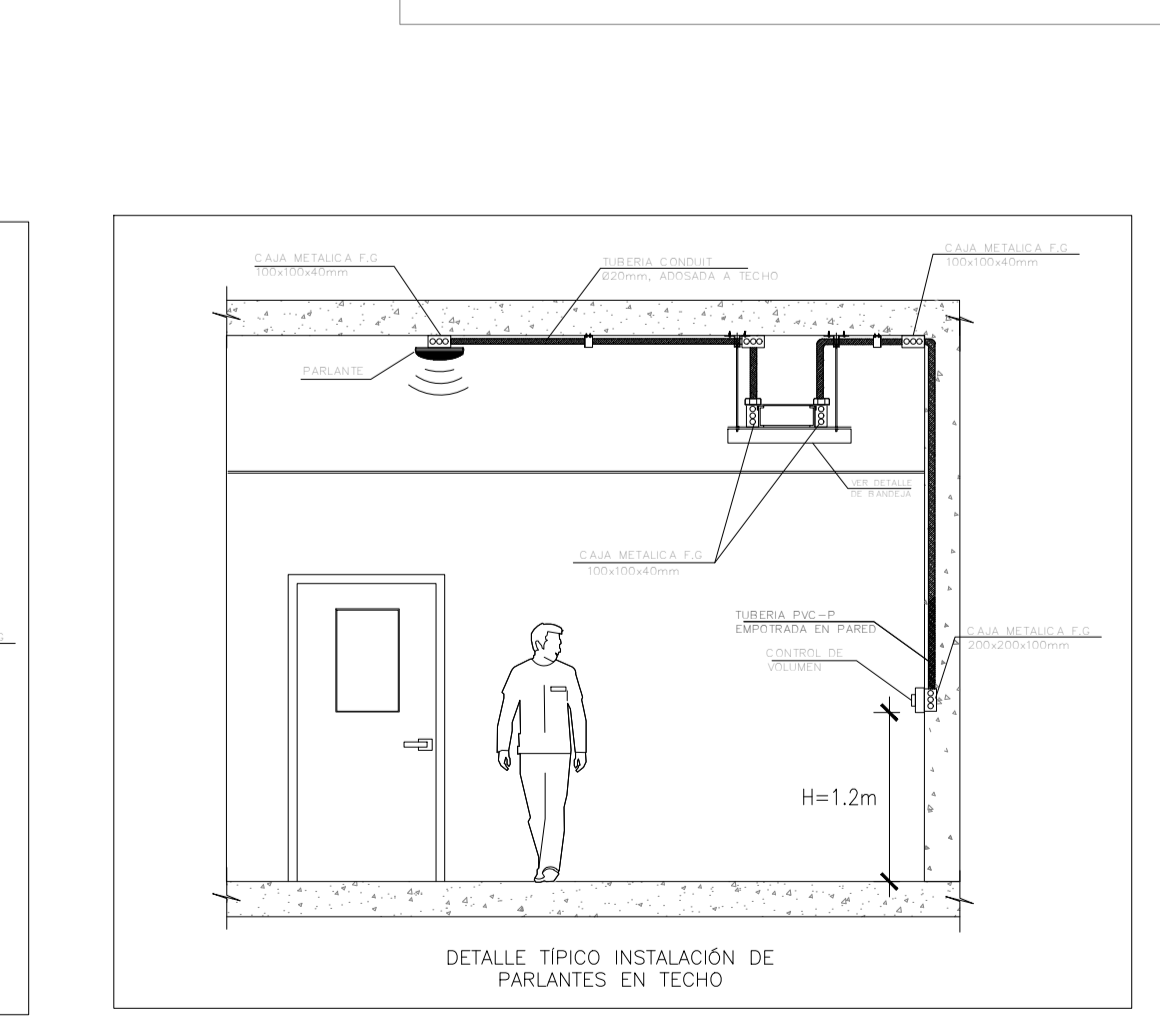
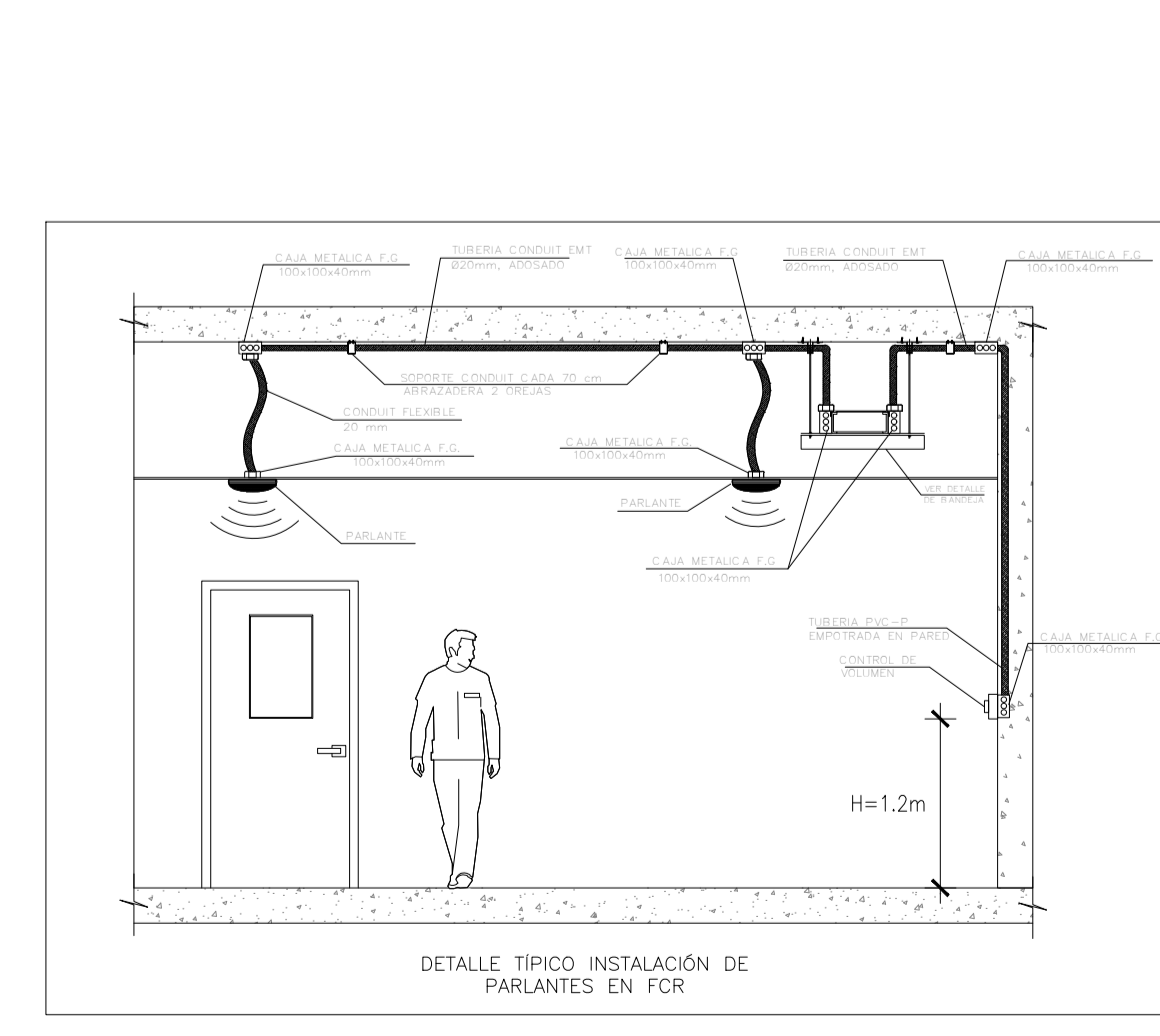
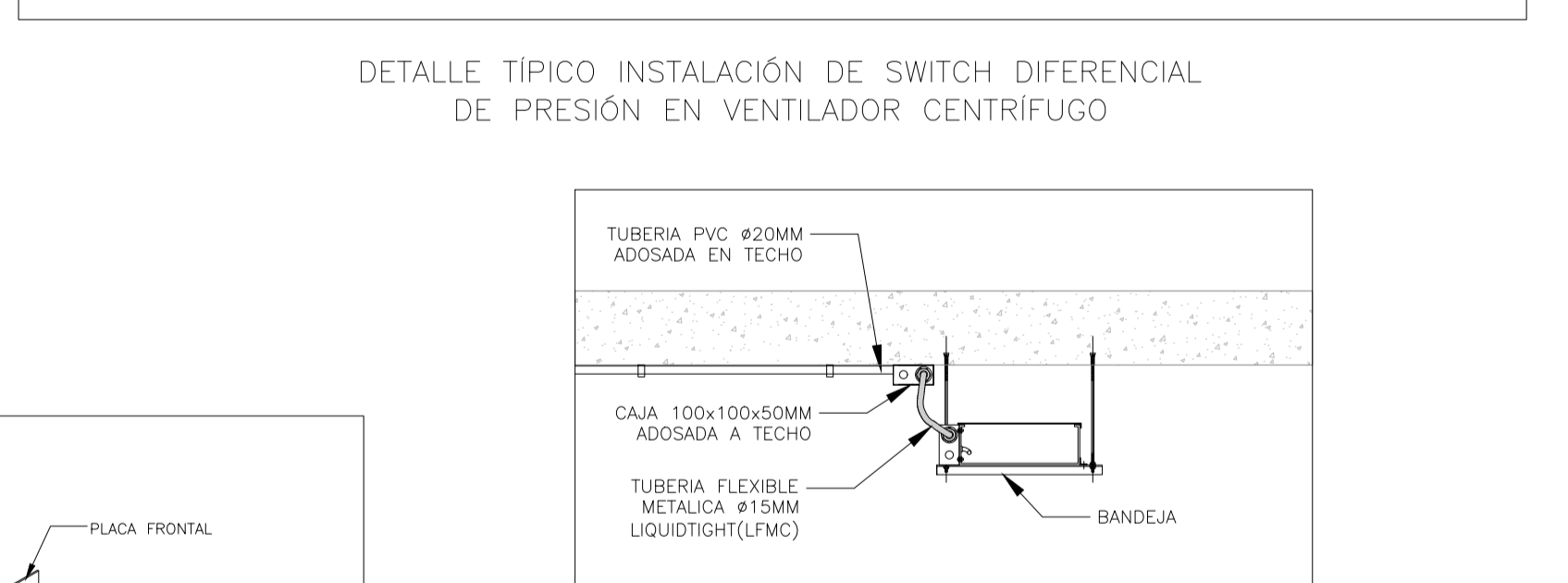
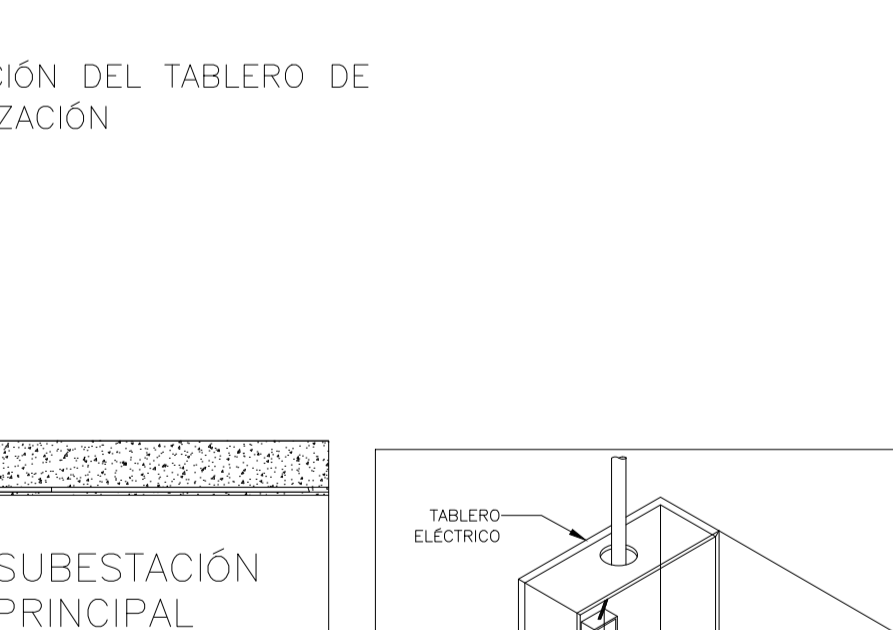
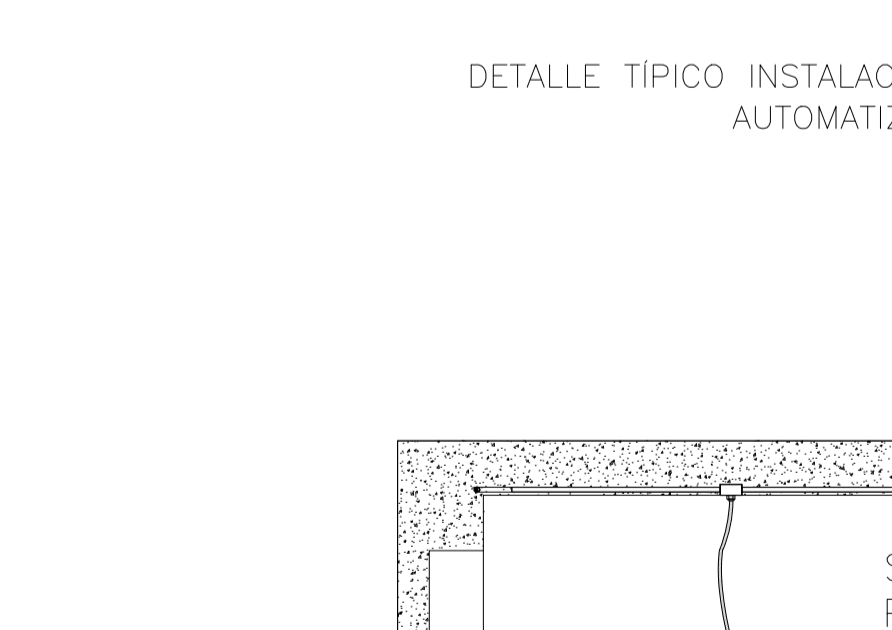
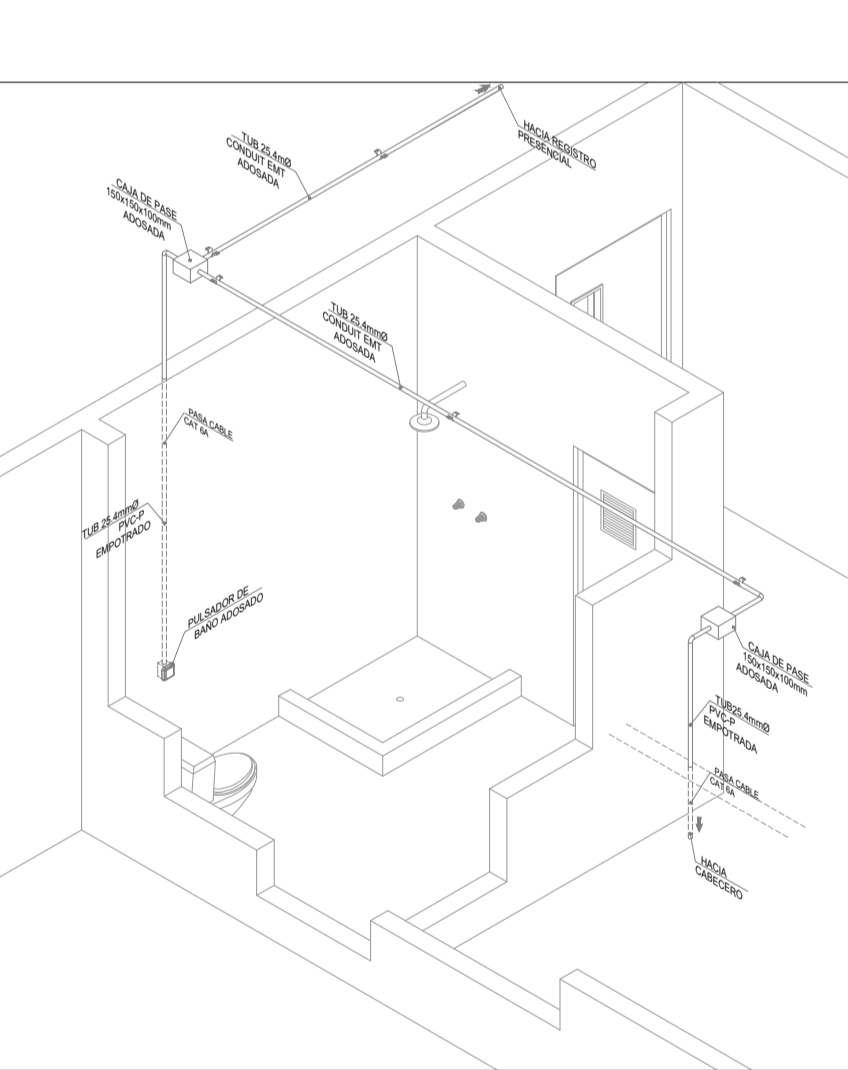
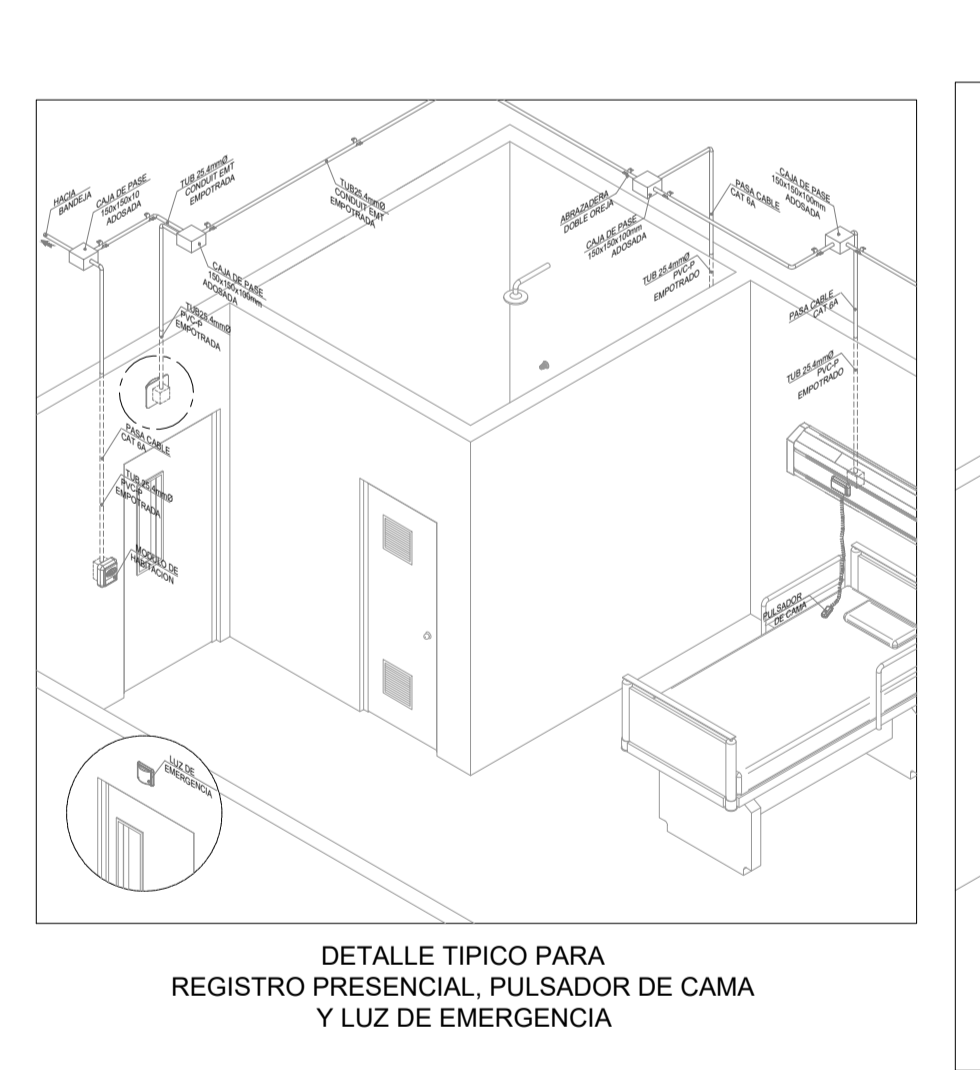
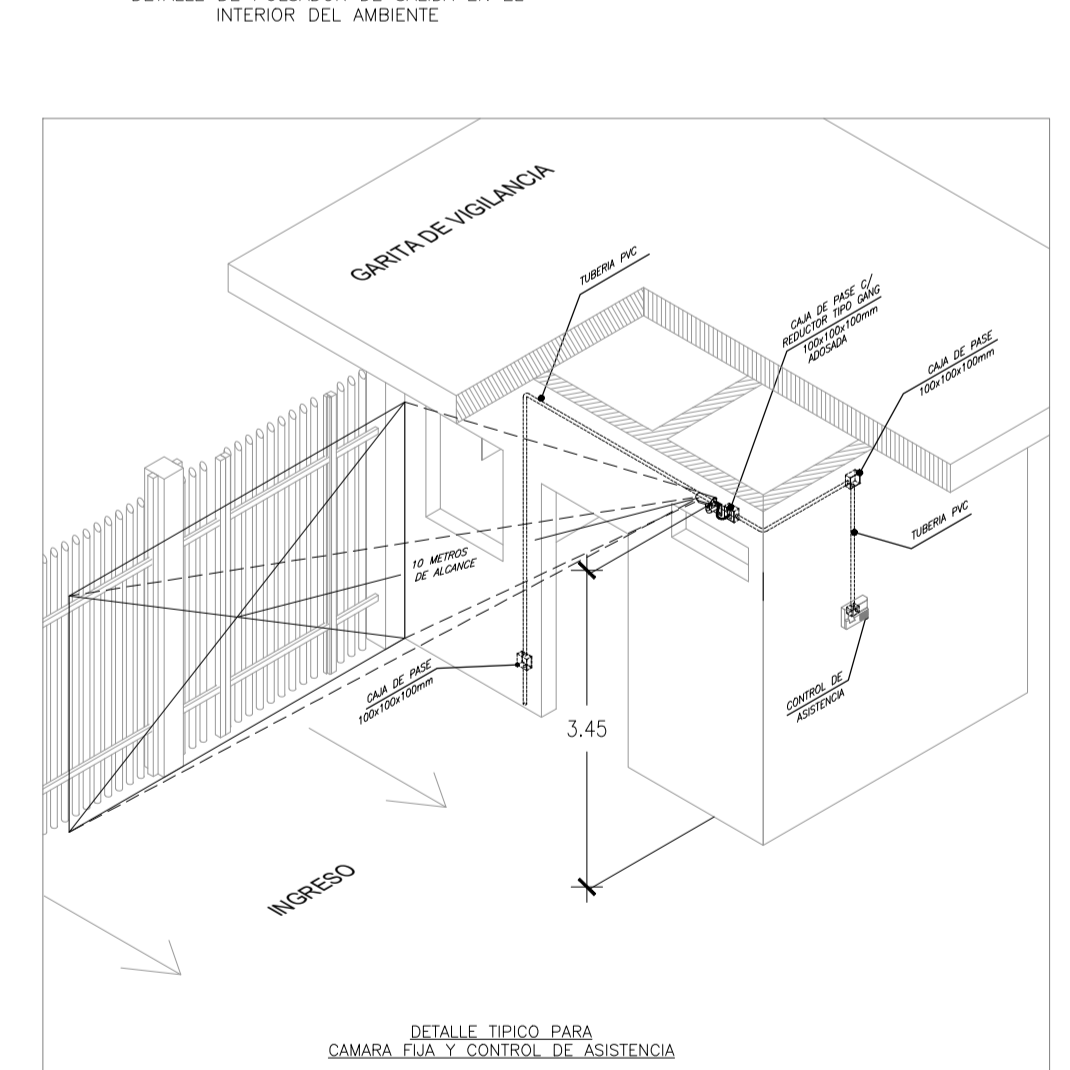
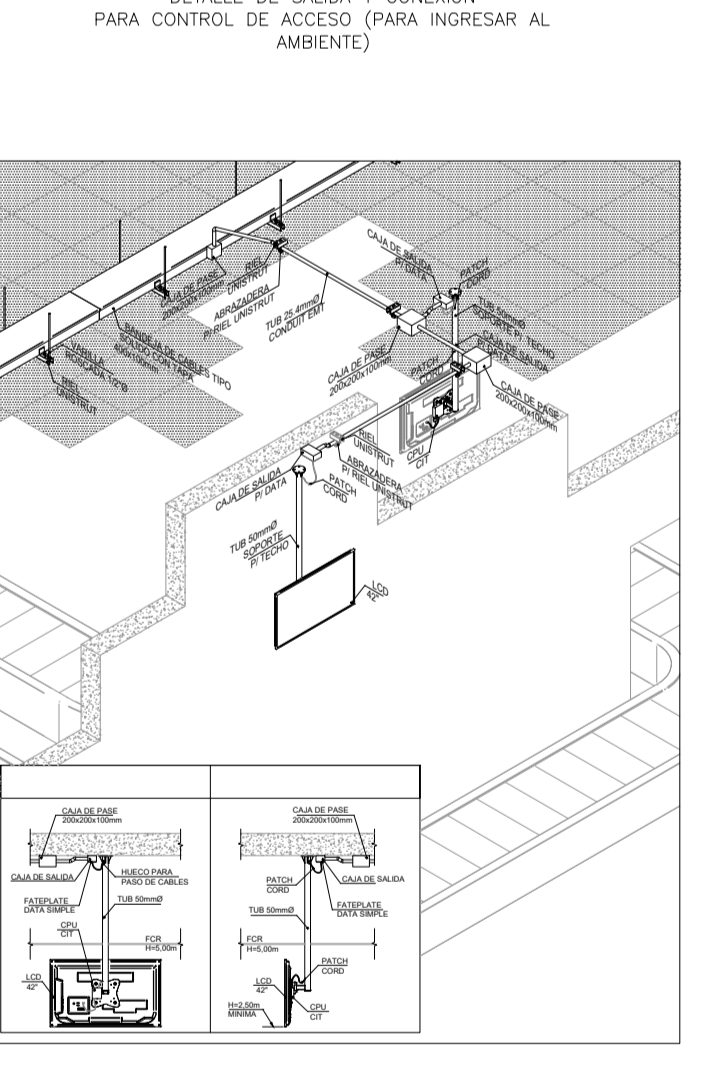
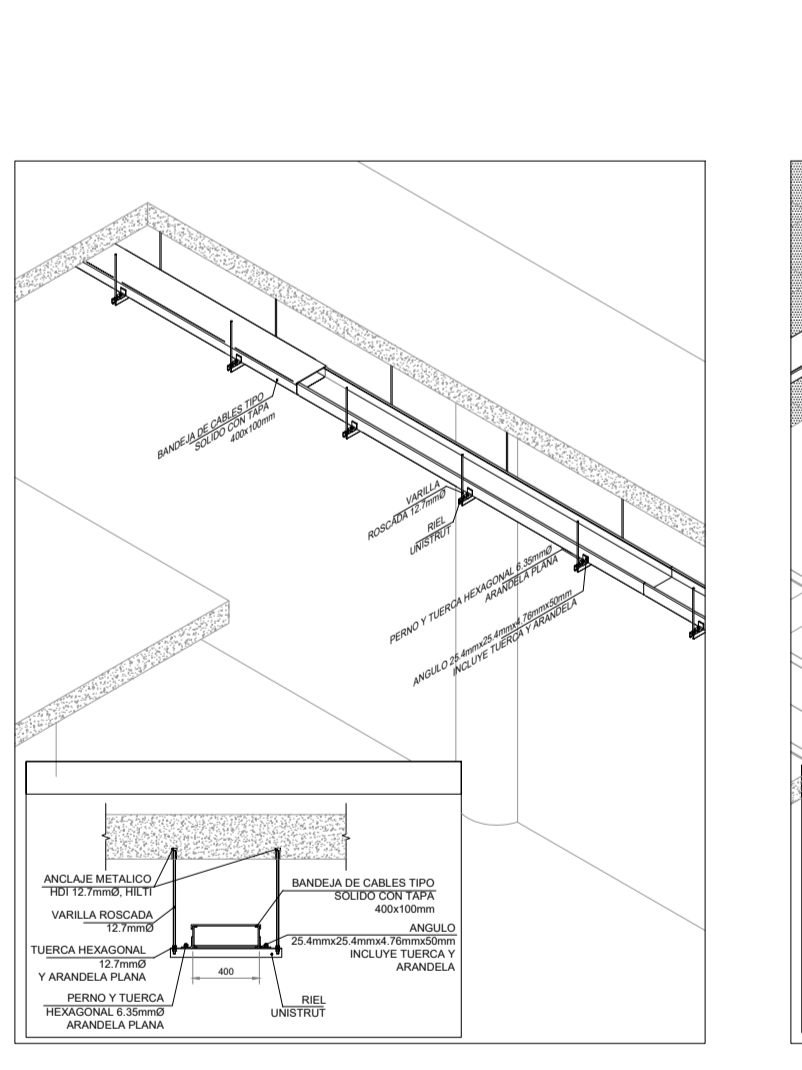
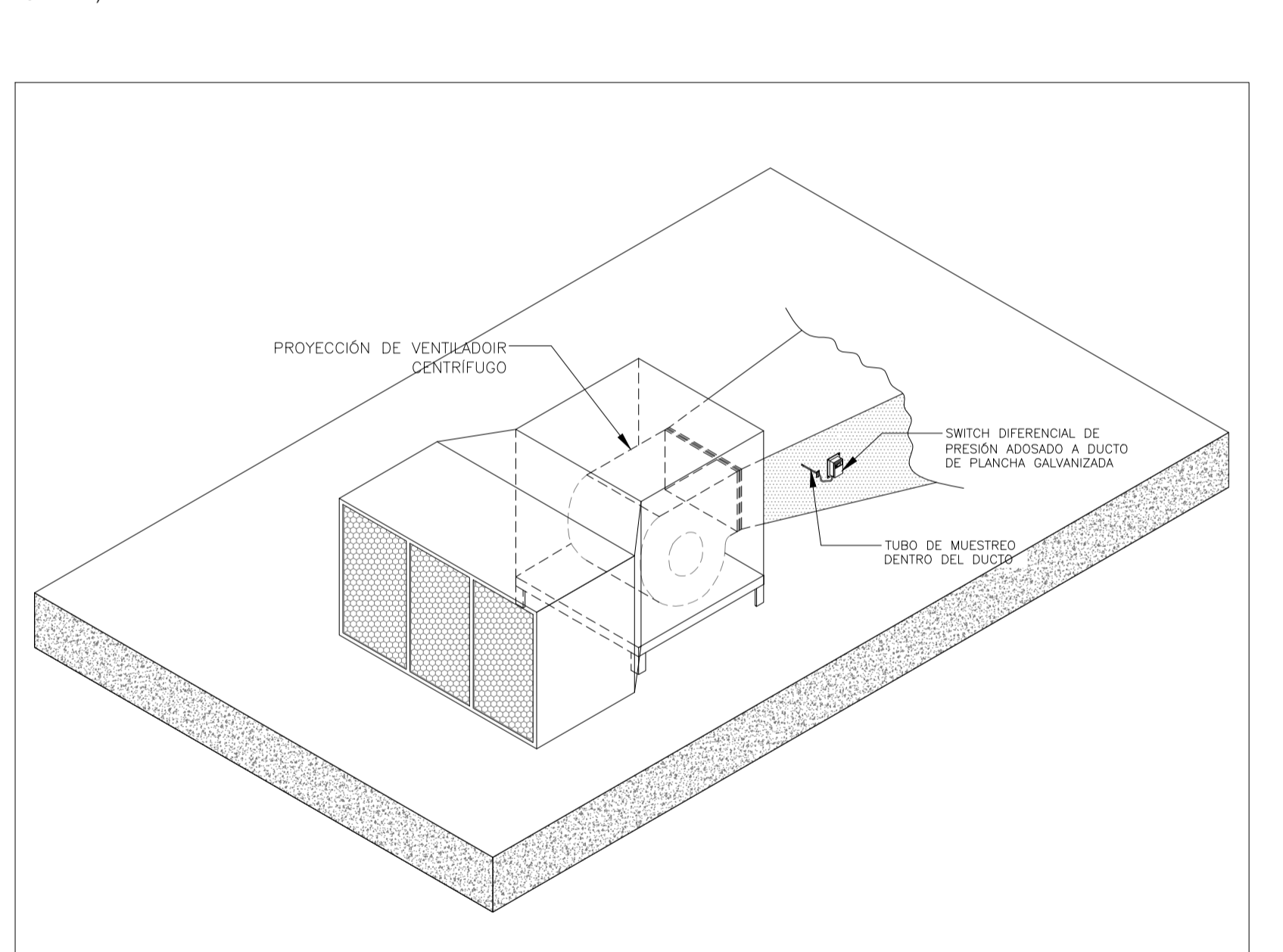
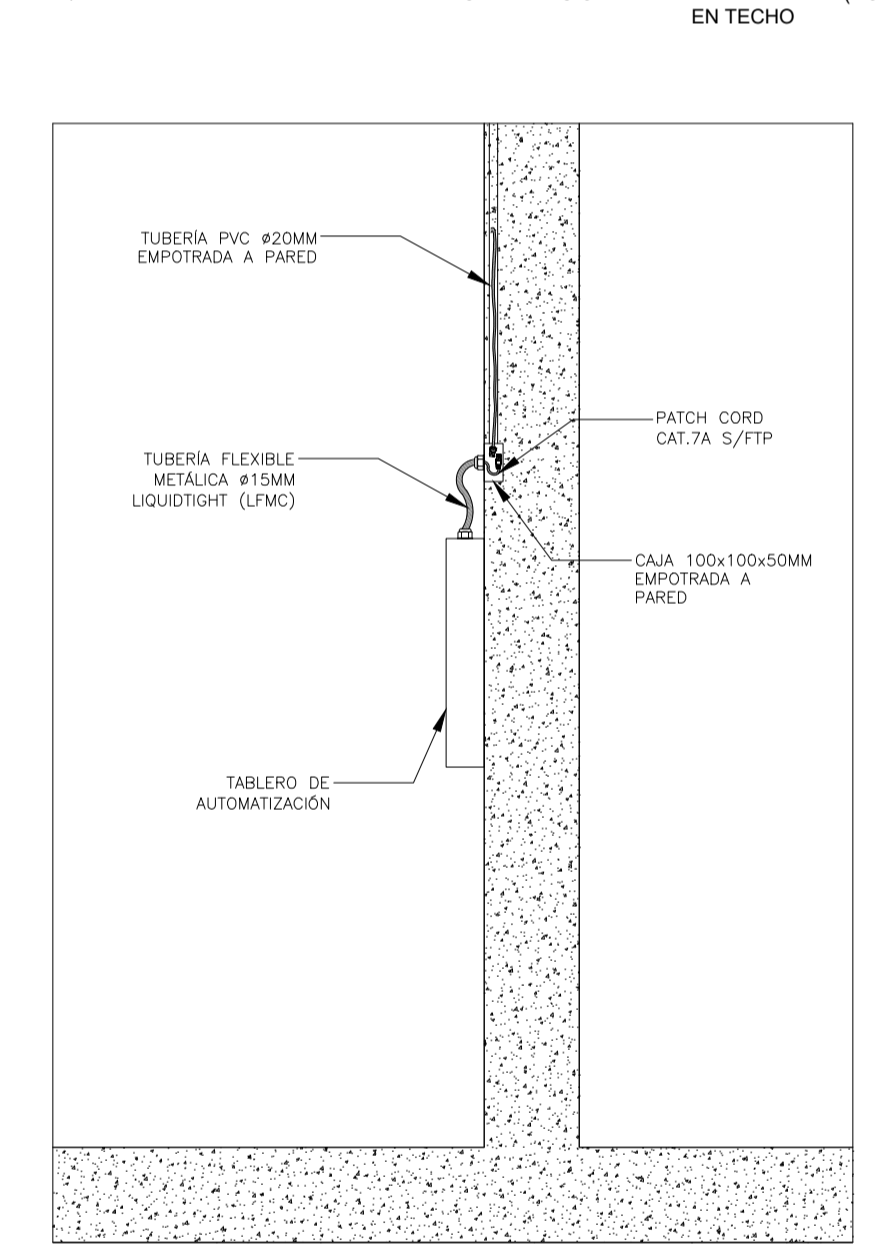
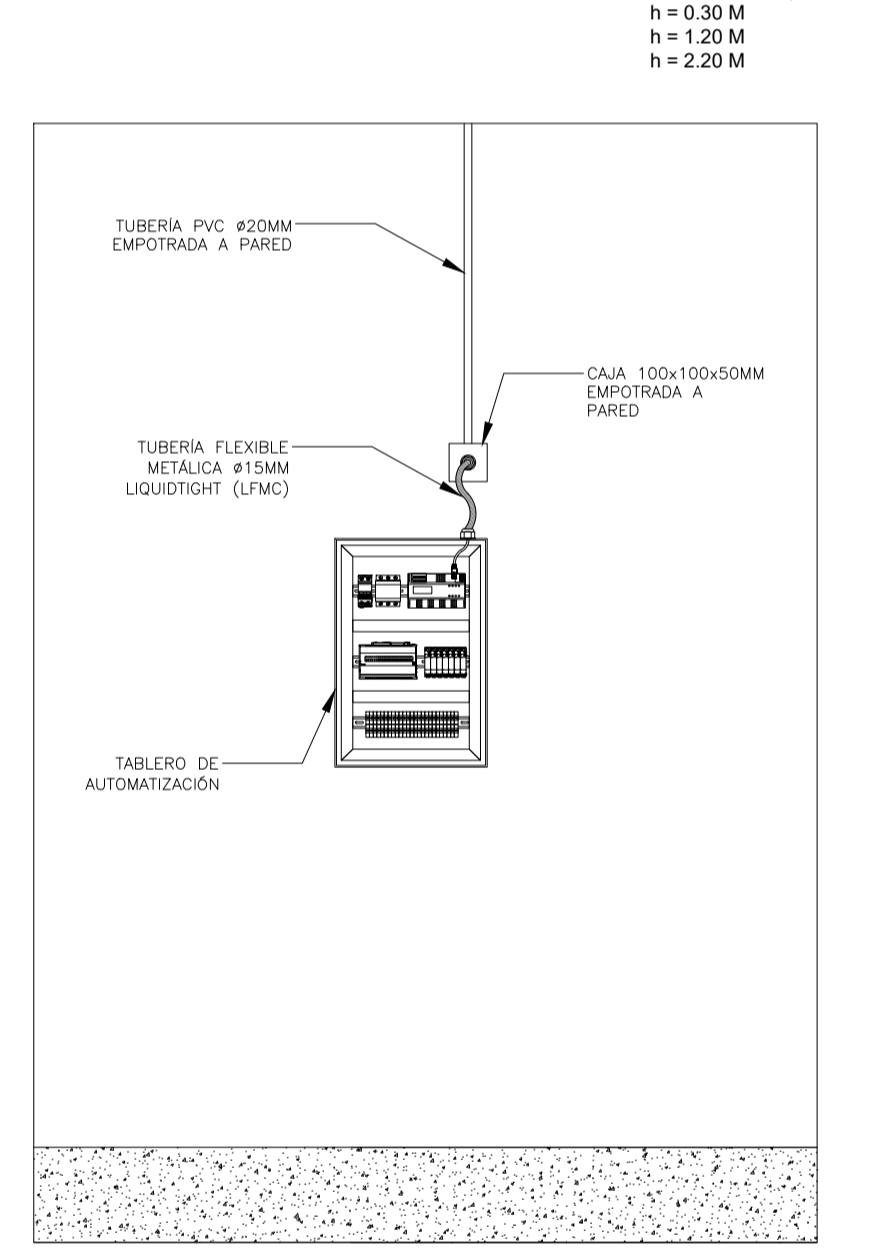
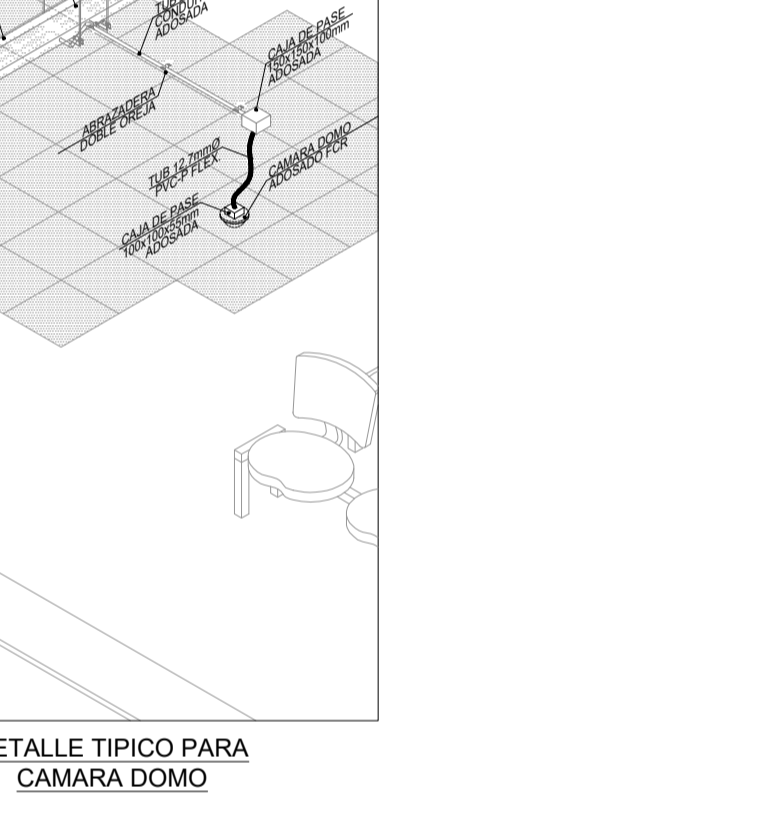
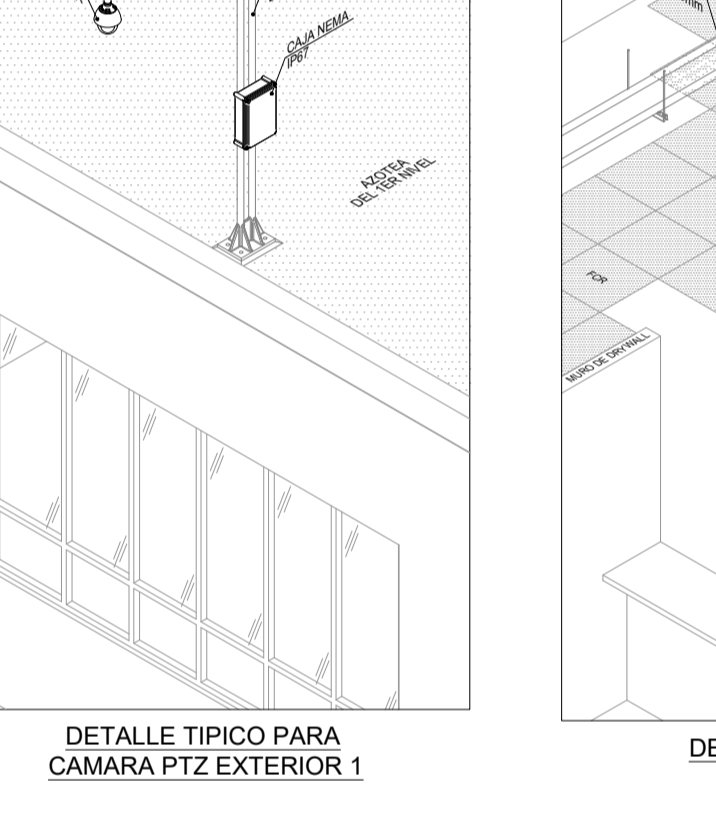
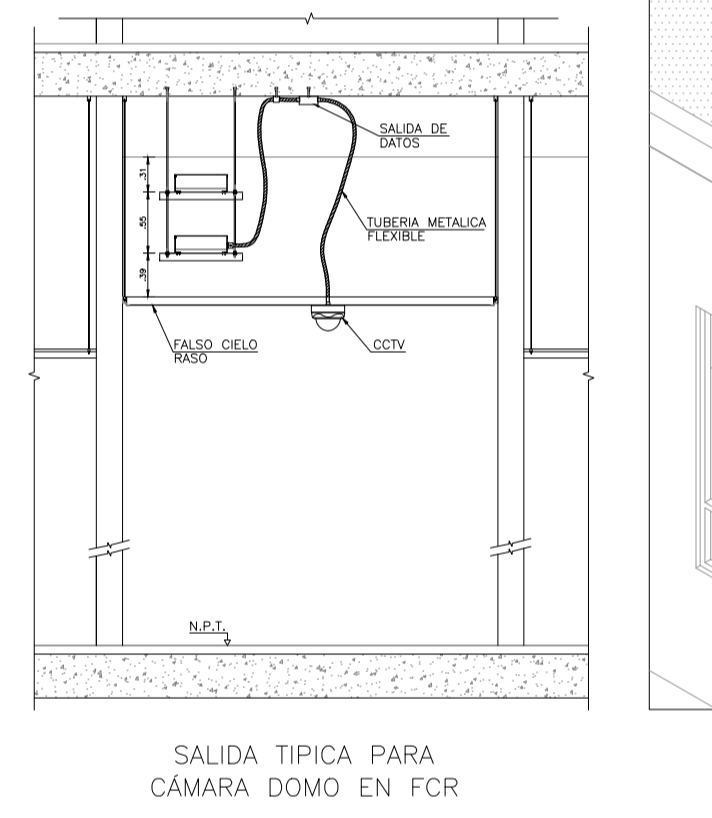
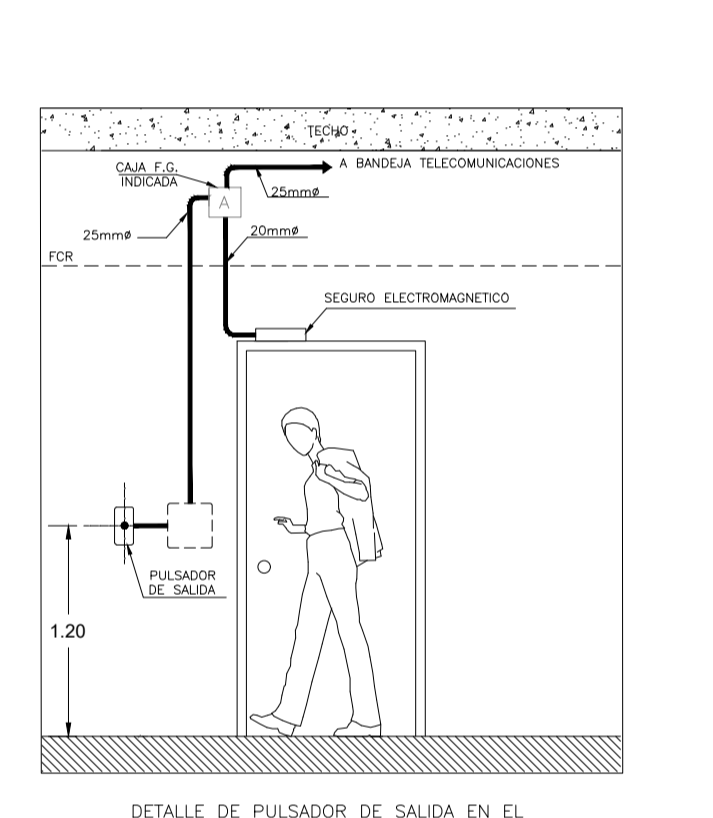
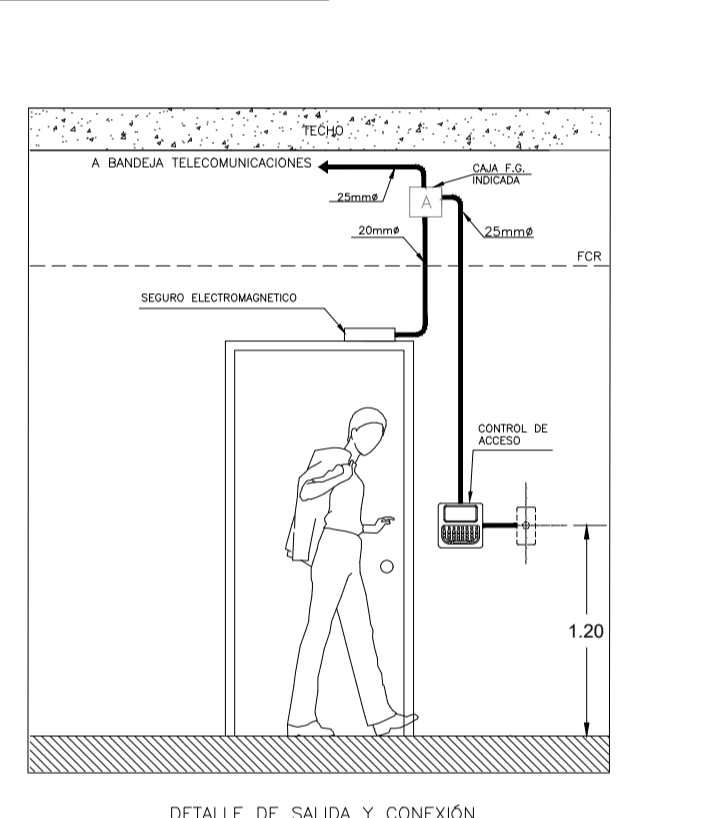
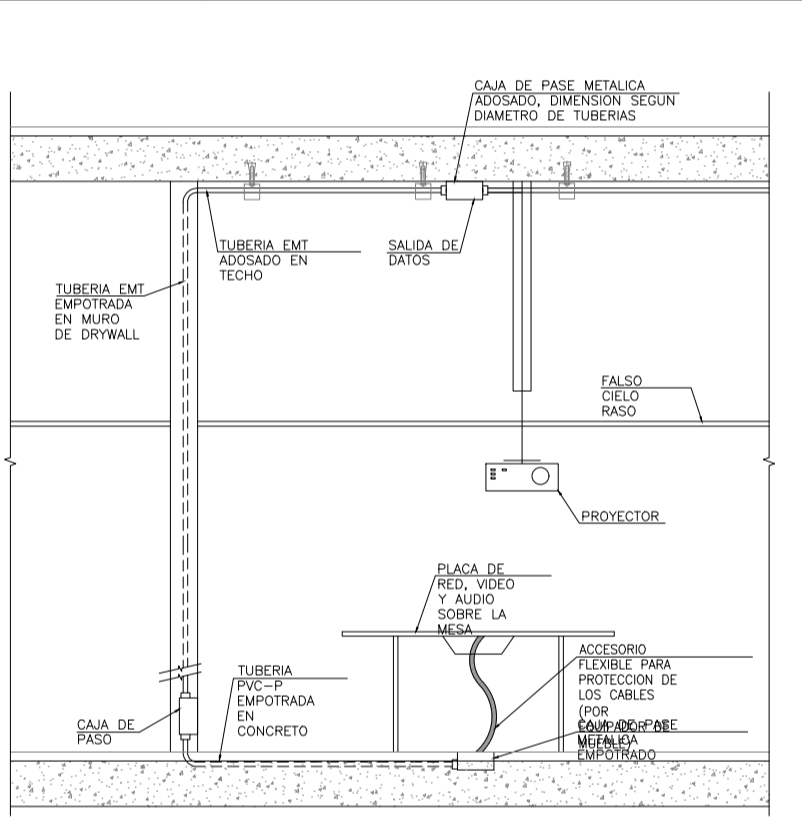
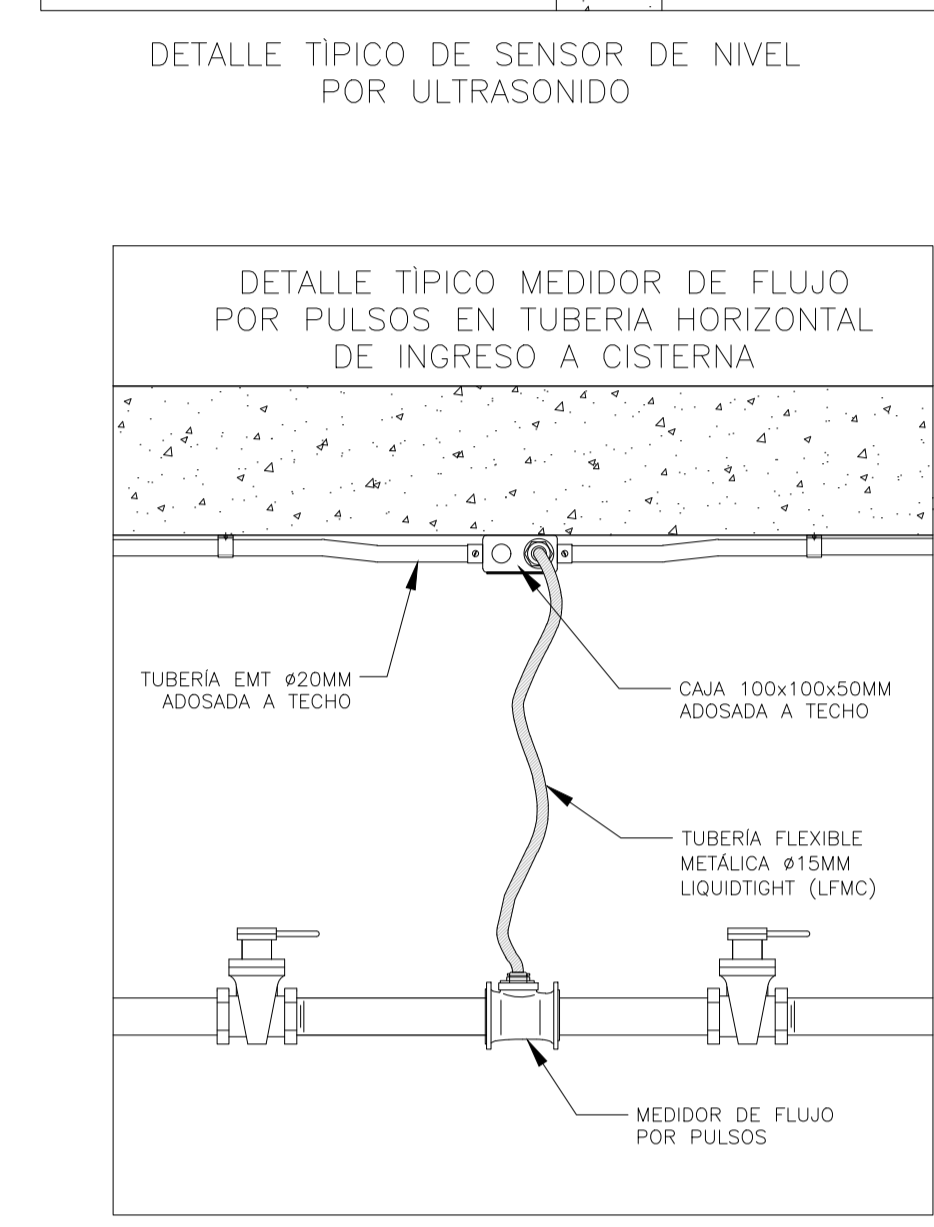
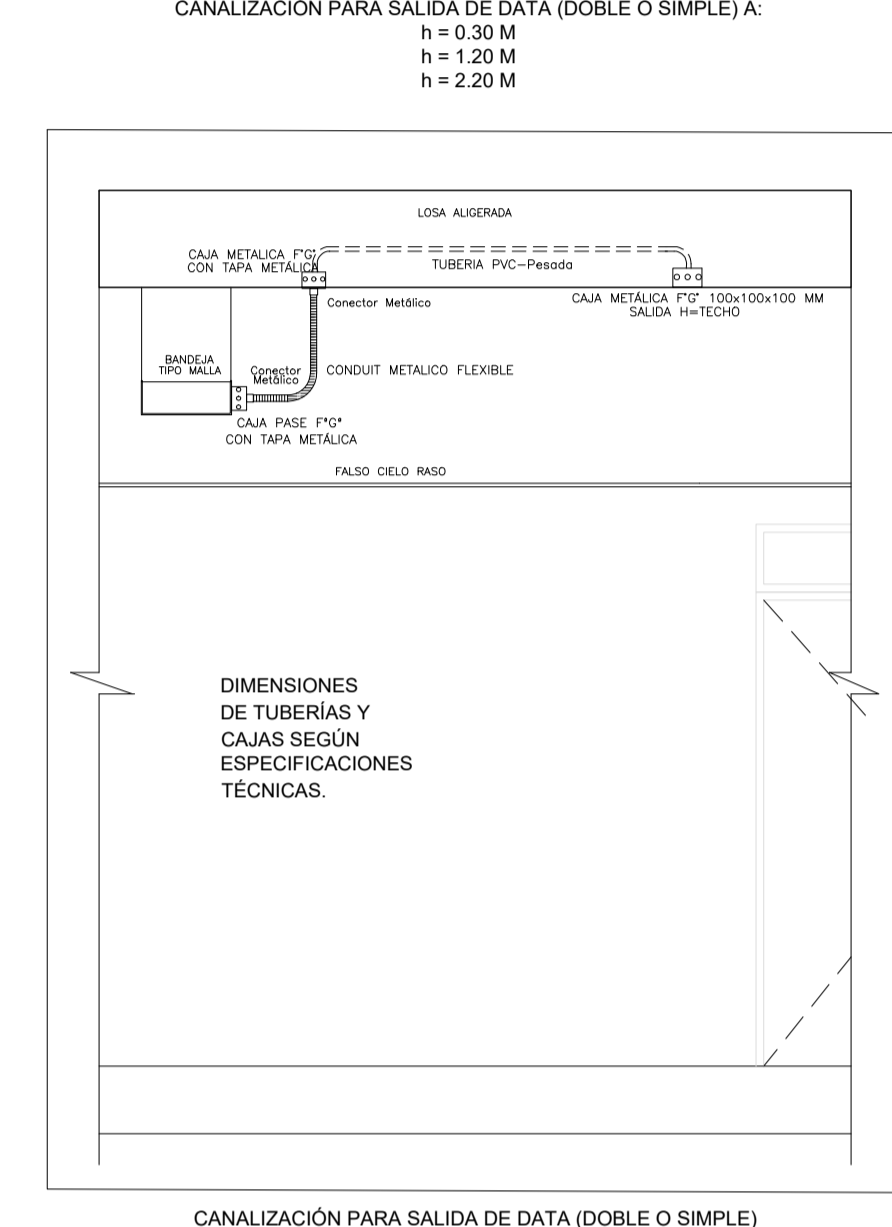
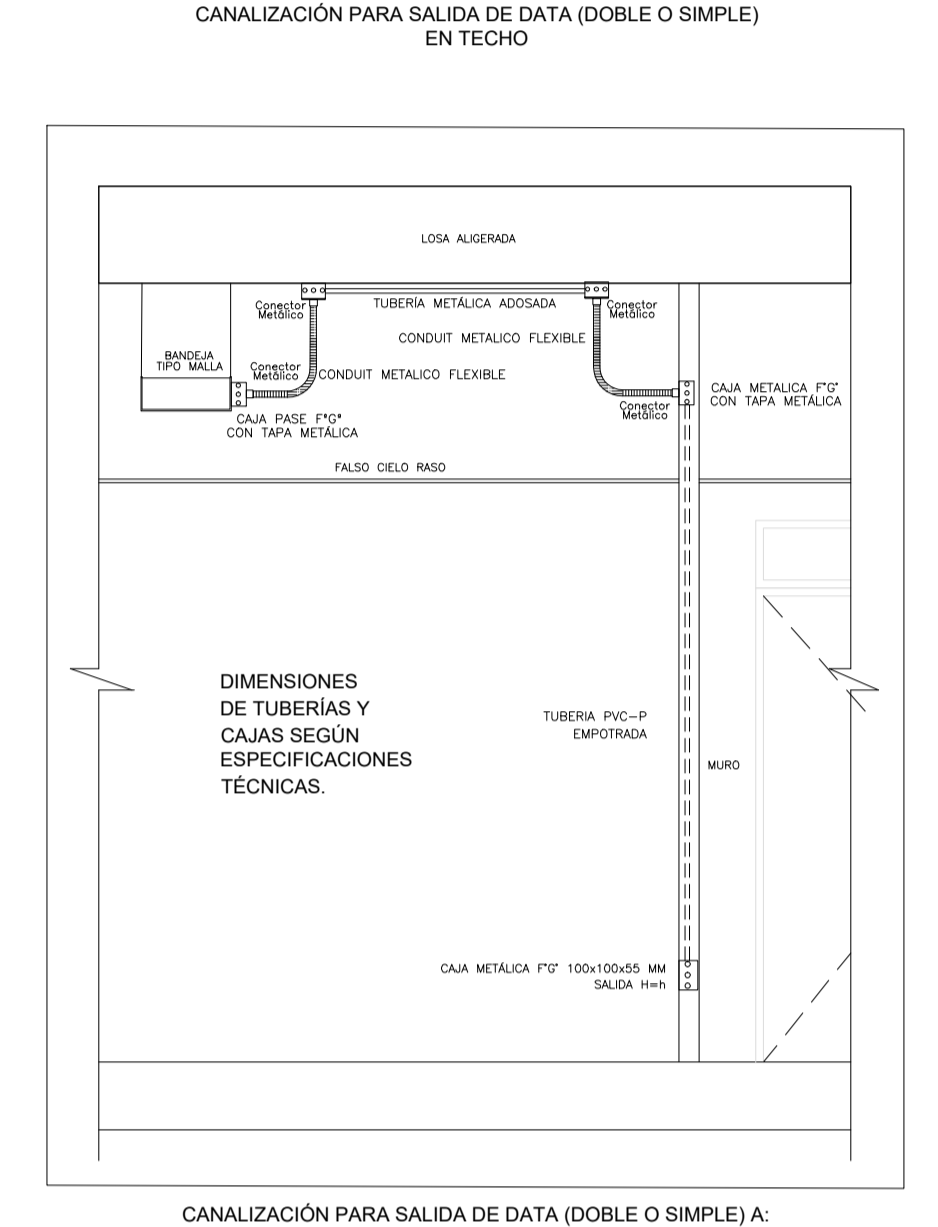
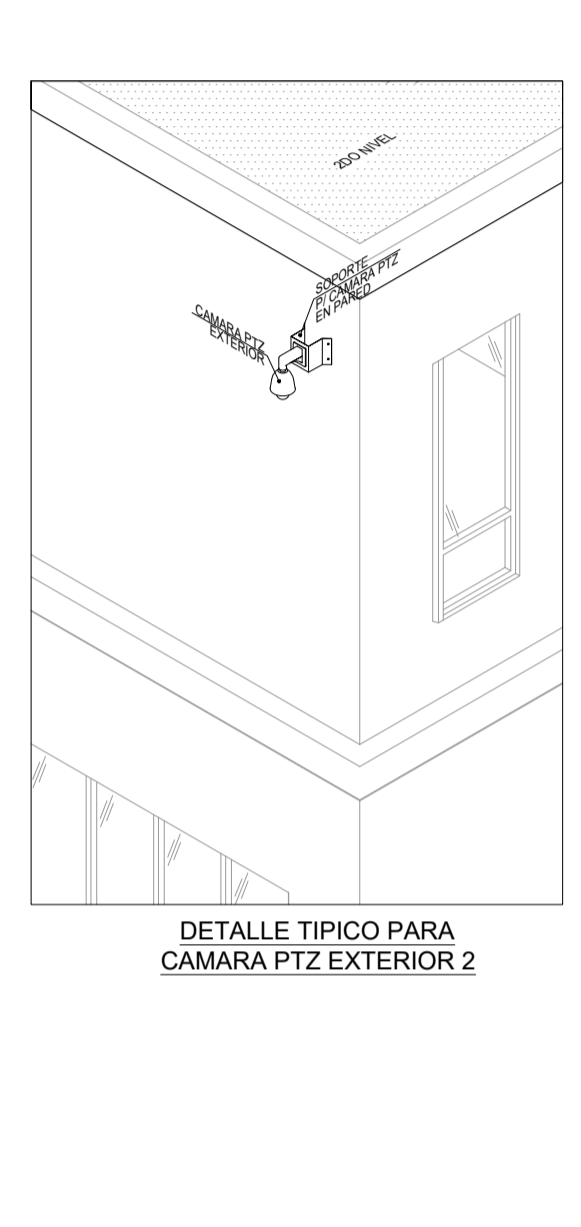
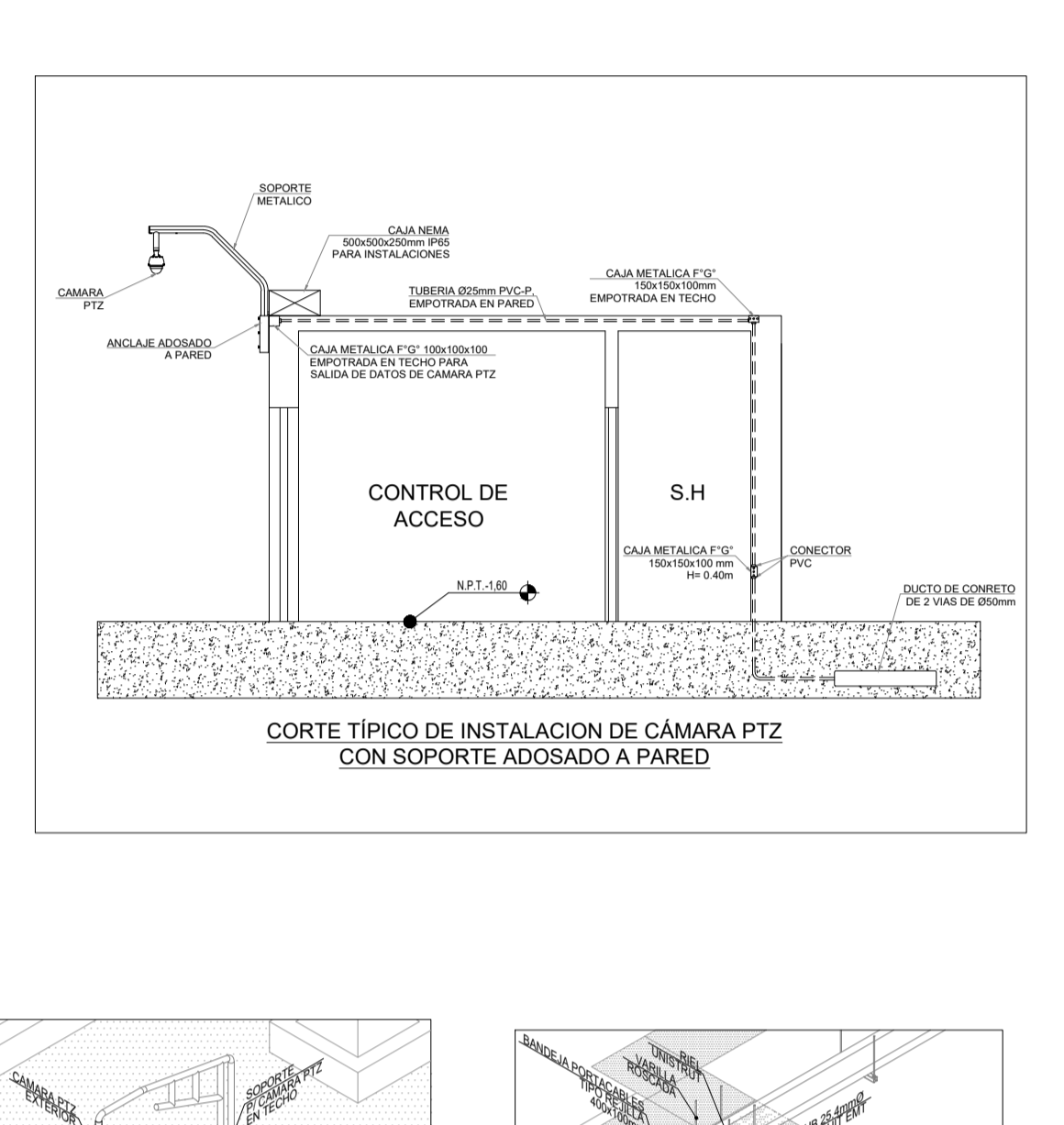
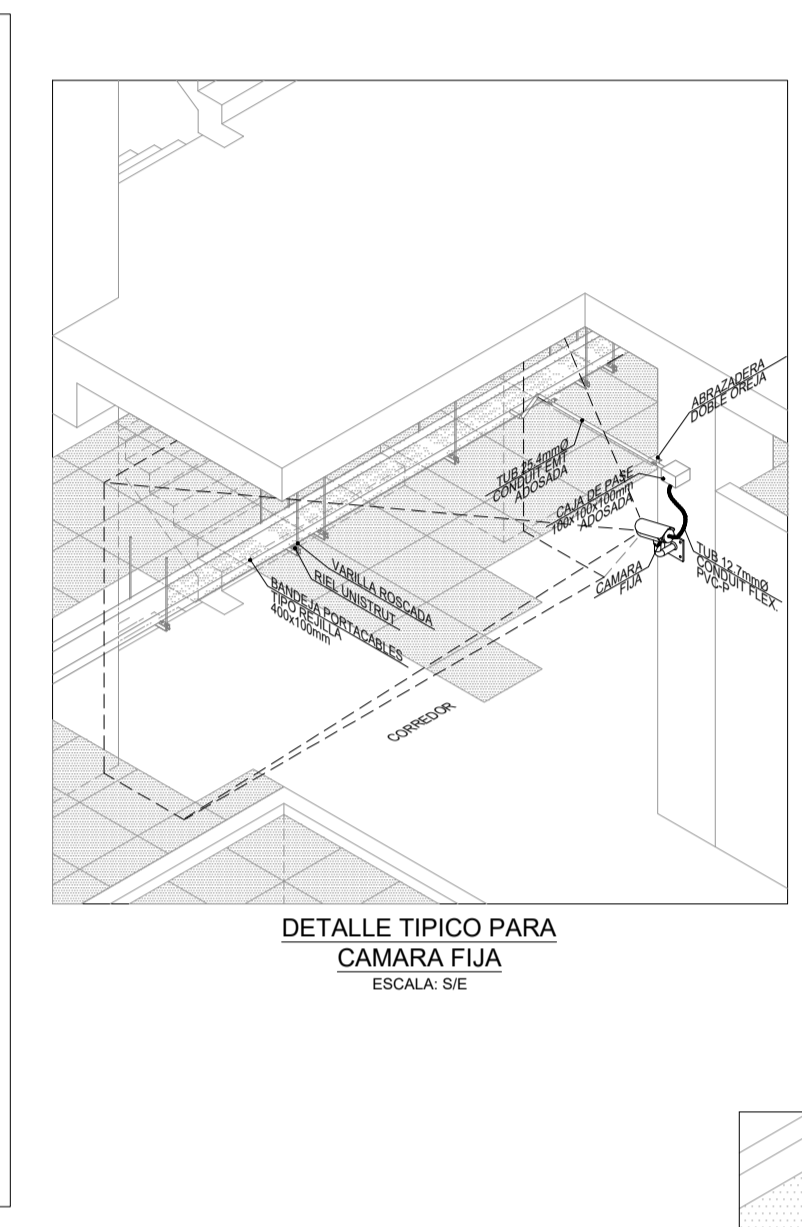
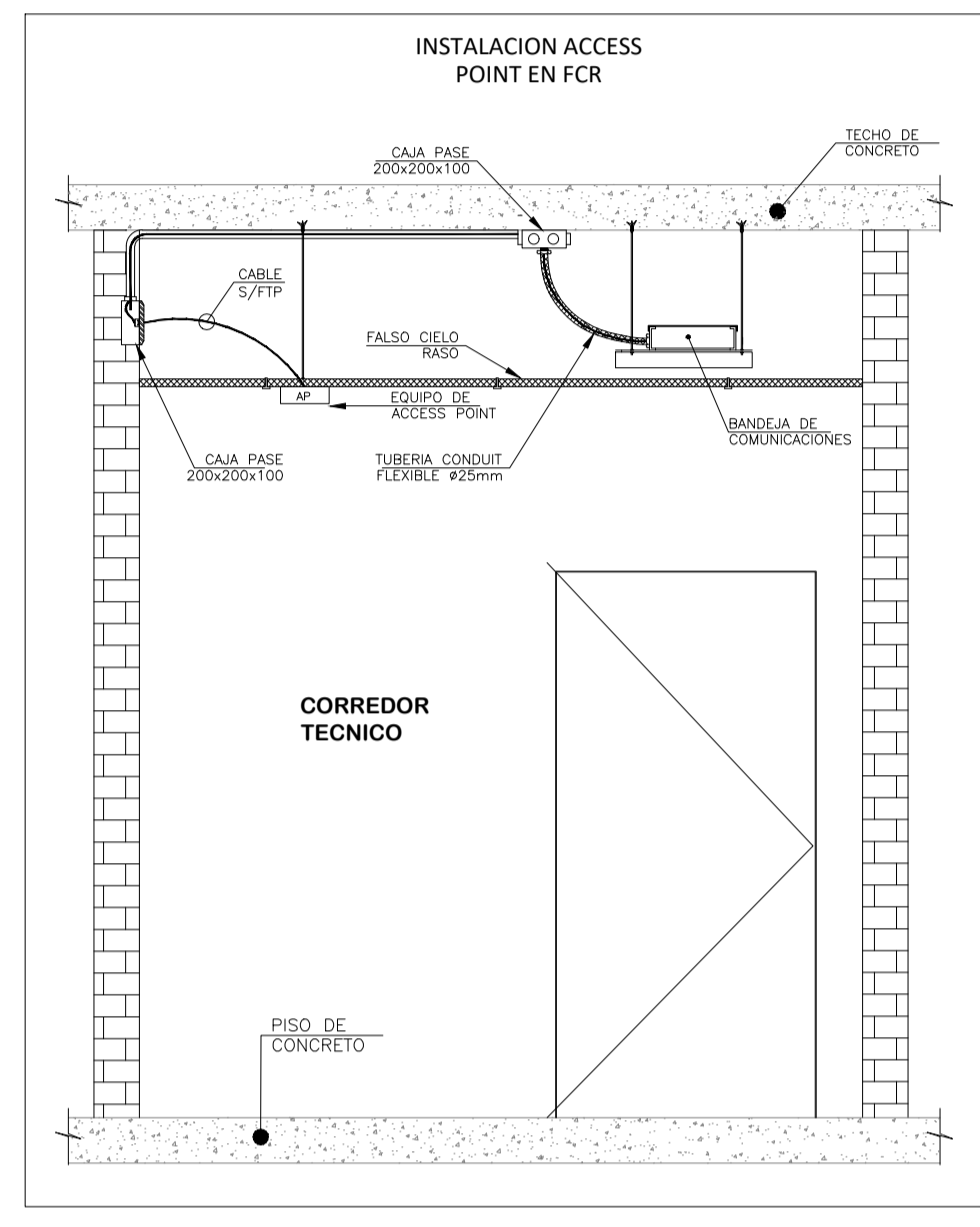
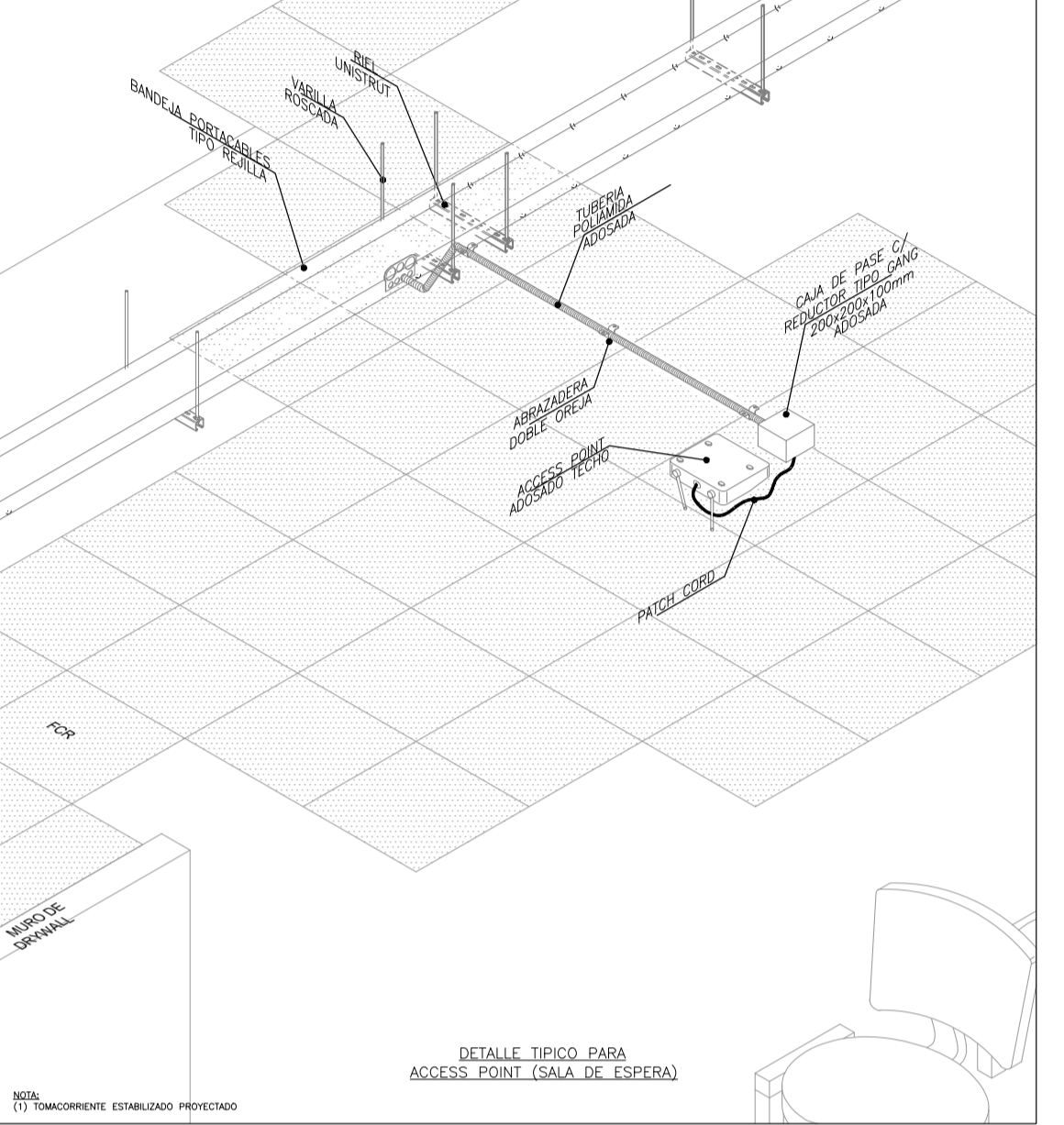
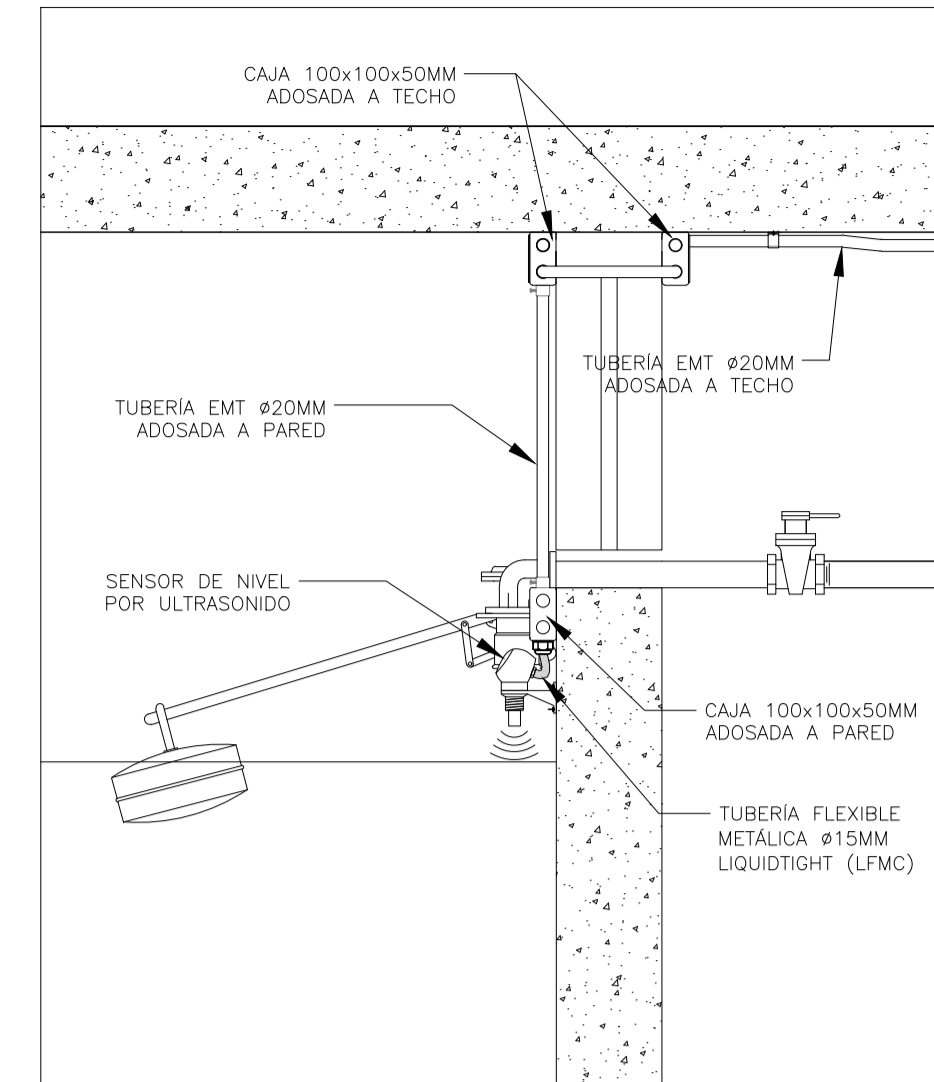
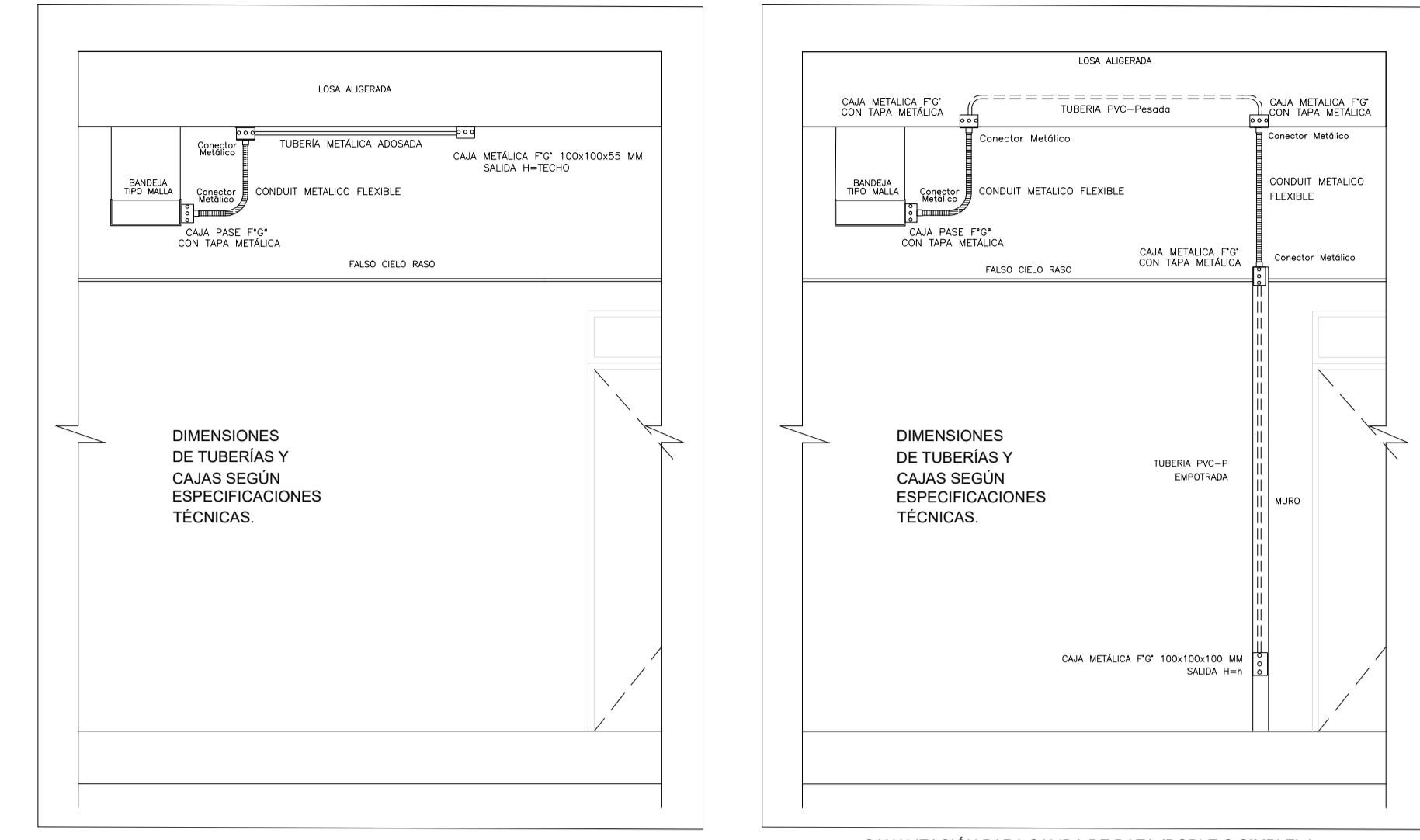
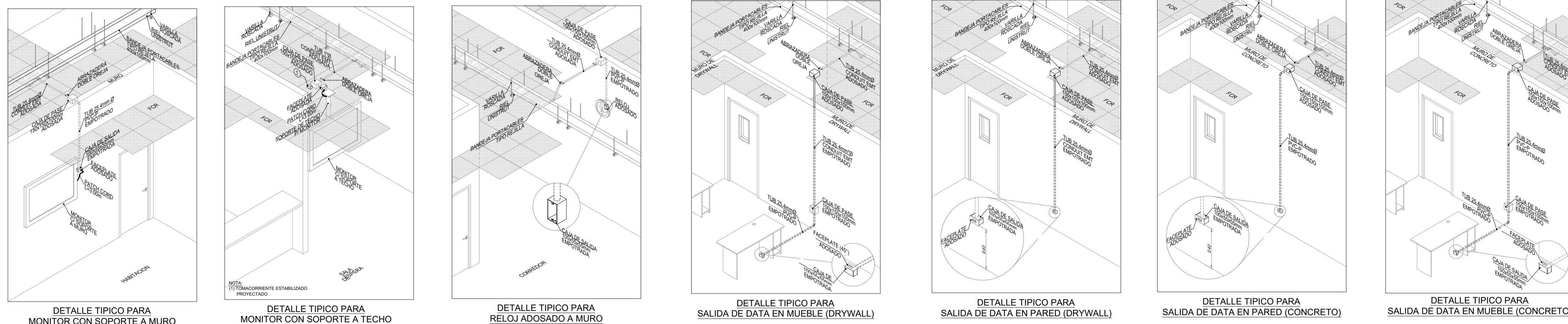

OBSERVACIONES

FIRMA DE PROYECTISTA

FIRMA DE SUPERVISOR

PLANO CLAVE

BOLETA N°	FECHA	USUARIO	COMENTARIOS
BOLETA N° 01	15/04/2022	ING. CARLOS D. GUZMAN UBILLUS	ELABORACION DEL PROYECTO
BOLETA N° 02	15/04/2022	ING. CARLOS D. GUZMAN UBILLUS	REVISION Y APROBACION
BOLETA N° 03	15/04/2022	ING. CARLOS D. GUZMAN UBILLUS	REVISION Y APROBACION
BOLETA N° 04	15/04/2022	ING. CARLOS D. GUZMAN UBILLUS	REVISION Y APROBACION
BOLETA N° 05	15/04/2022	ING. CARLOS D. GUZMAN UBILLUS	REVISION Y APROBACION
BOLETA N° 06	15/04/2022	ING. CARLOS D. GUZMAN UBILLUS	REVISION Y APROBACION
BOLETA N° 07	15/04/2022	ING. CARLOS D. GUZMAN UBILLUS	REVISION Y APROBACION
BOLETA N° 08	15/04/2022	ING. CARLOS D. GUZMAN UBILLUS	REVISION Y APROBACION
BOLETA N° 09	15/04/2022	ING. CARLOS D. GUZMAN UBILLUS	REVISION Y APROBACION
BOLETA N° 10	15/04/2022	ING. CARLOS D. GUZMAN UBILLUS	REVISION Y APROBACION

PROYECTO: ELABORACION DEL EXPEDIENTE TECNICO, EQUIPAMIENTO Y CONTINGENCIA DEL PROYECTO RECONSTRUCCION DEL HOSPITAL SAUL GARRIDO ROSILLO II-1, DISTRITO DE TUMBES, PROVINCIA DE TUMBES, DEPARTAMENTO DE TUMBES

UBICACION: TUMBES, TUMBES, TUMBES

ESPECIALIDAD: COMUNICACIONES

PLANO: DETALLES DE SCE, SSE, SCD Y BMS

ELABORADO POR: CONSORCIO CONSULTOR SAUL GARRIDO RUC 2080779638

PROFESIONAL RESPONSABLE: ING. CARLOS D. GUZMAN UBILLUS CIP 048597

FECHA: ABRIL 2022